

\*  
LEM

GUIDANCE, NAVIGATION AND CONTROL SUBSYSTEM

COURSE NO. 30315, 30415

STUDY GUIDE

FOR TRAINING PURPOSES ONLY

DATE MARCH 1, 1966

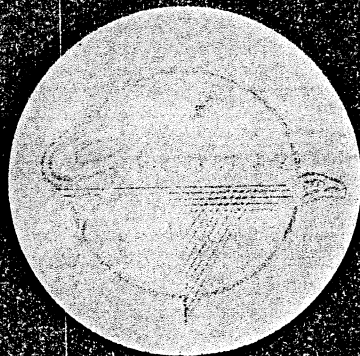

IMU CAGE  
ON  
  
OFF

UPLINK ACTY	TEMP
NO ATT	GIMBAL LOCK
STBY	PROG
KEY REL	RESTART
OPP ERR	TRACKER

CMPTR ACTY	PROG
	13
VERB	NOUN
33	13
-92311	
+13270	
-46514	

VERB	+	7	8	9	CLR	ENTR
NOUN	-	4	5	6	STBY	RSET
	0	1	2	3	KEY REL	

PANEL IV LM2

T30900-93  
APR 67

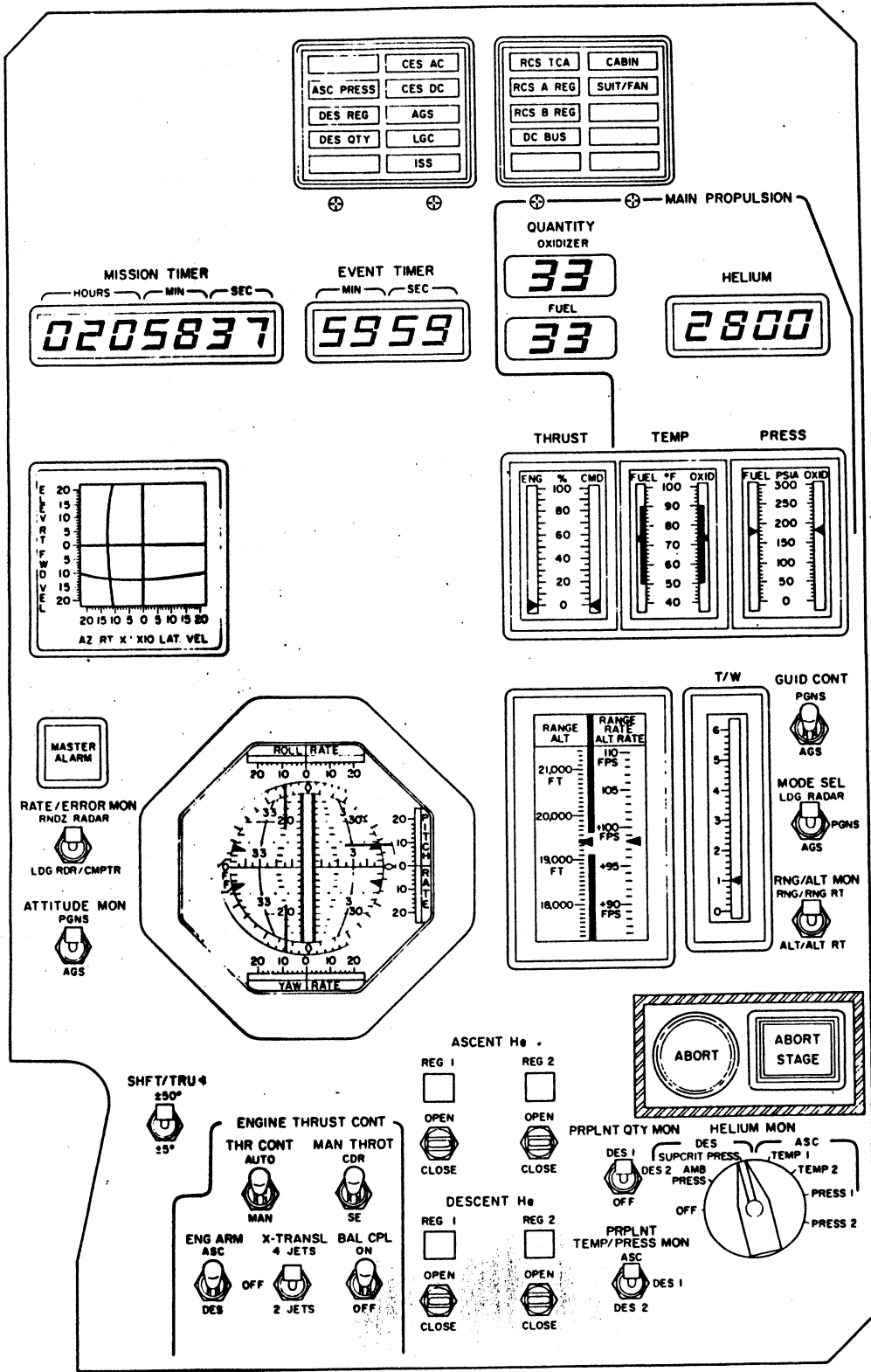

PANEL 1  
LM 2

T30900-85  
APR 67

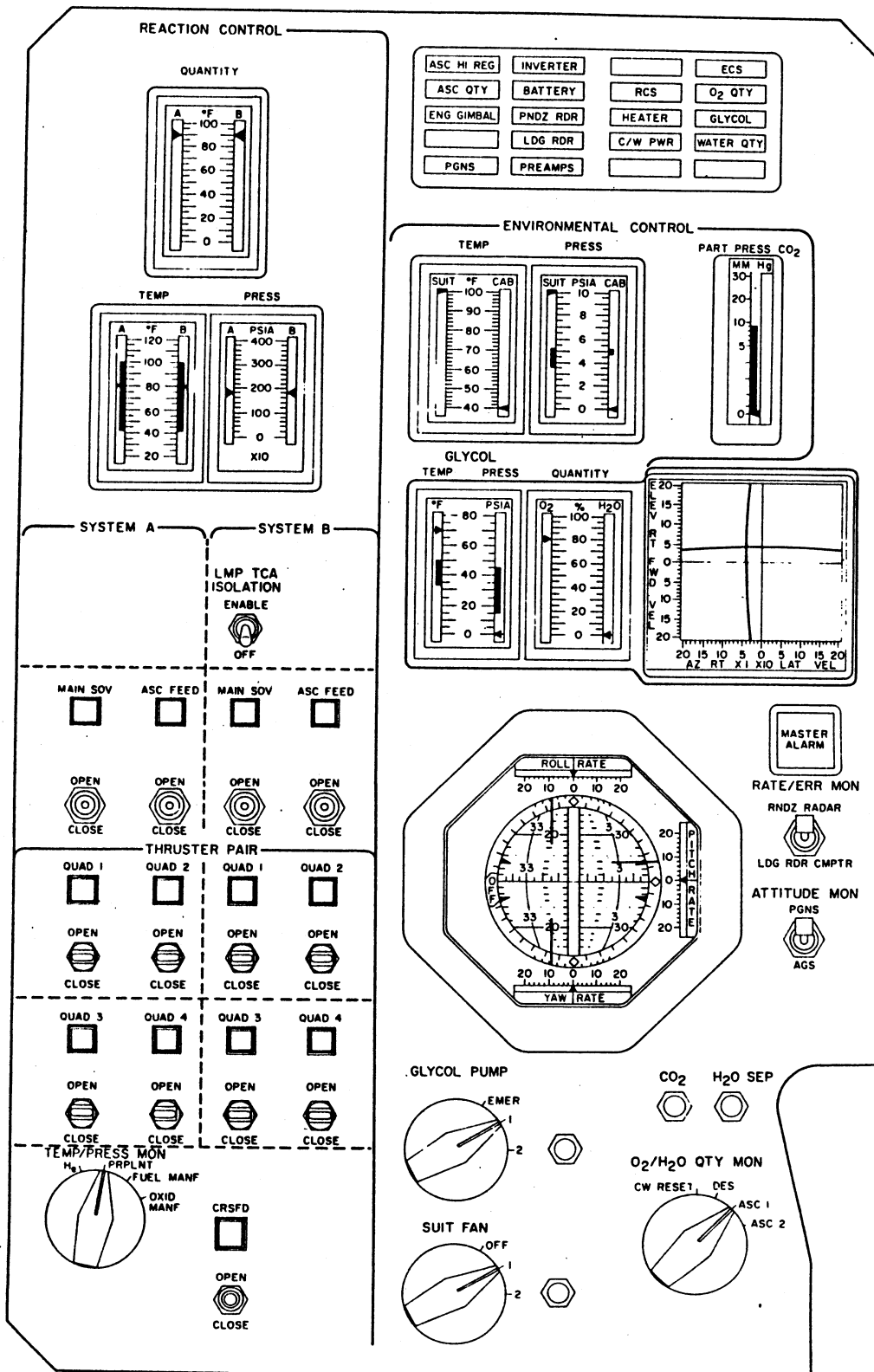

PANEL II  
LM 2



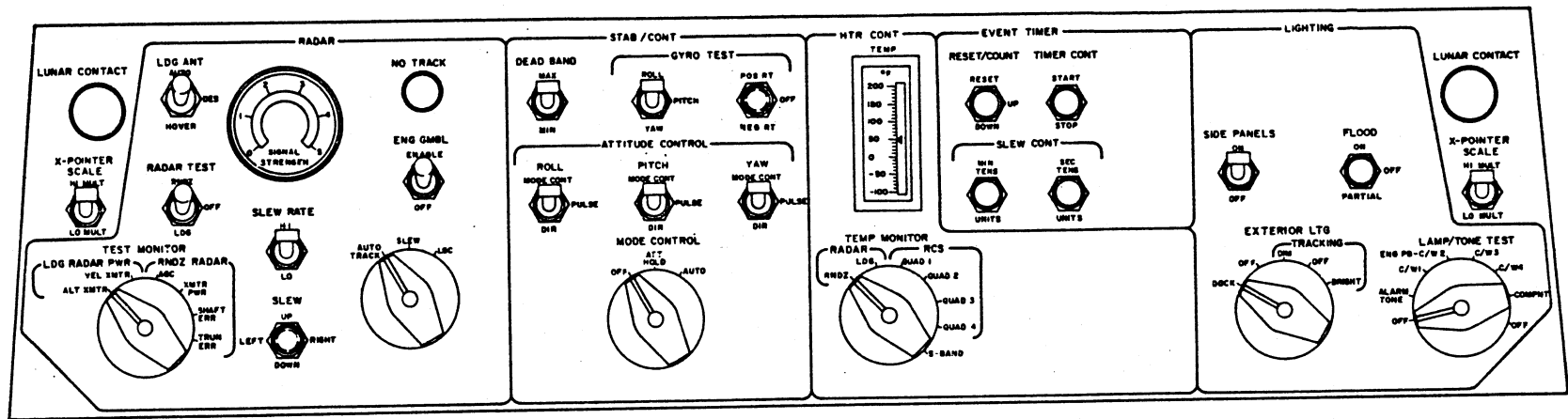

PANEL III  
LM2

T30900-87  
APR 67

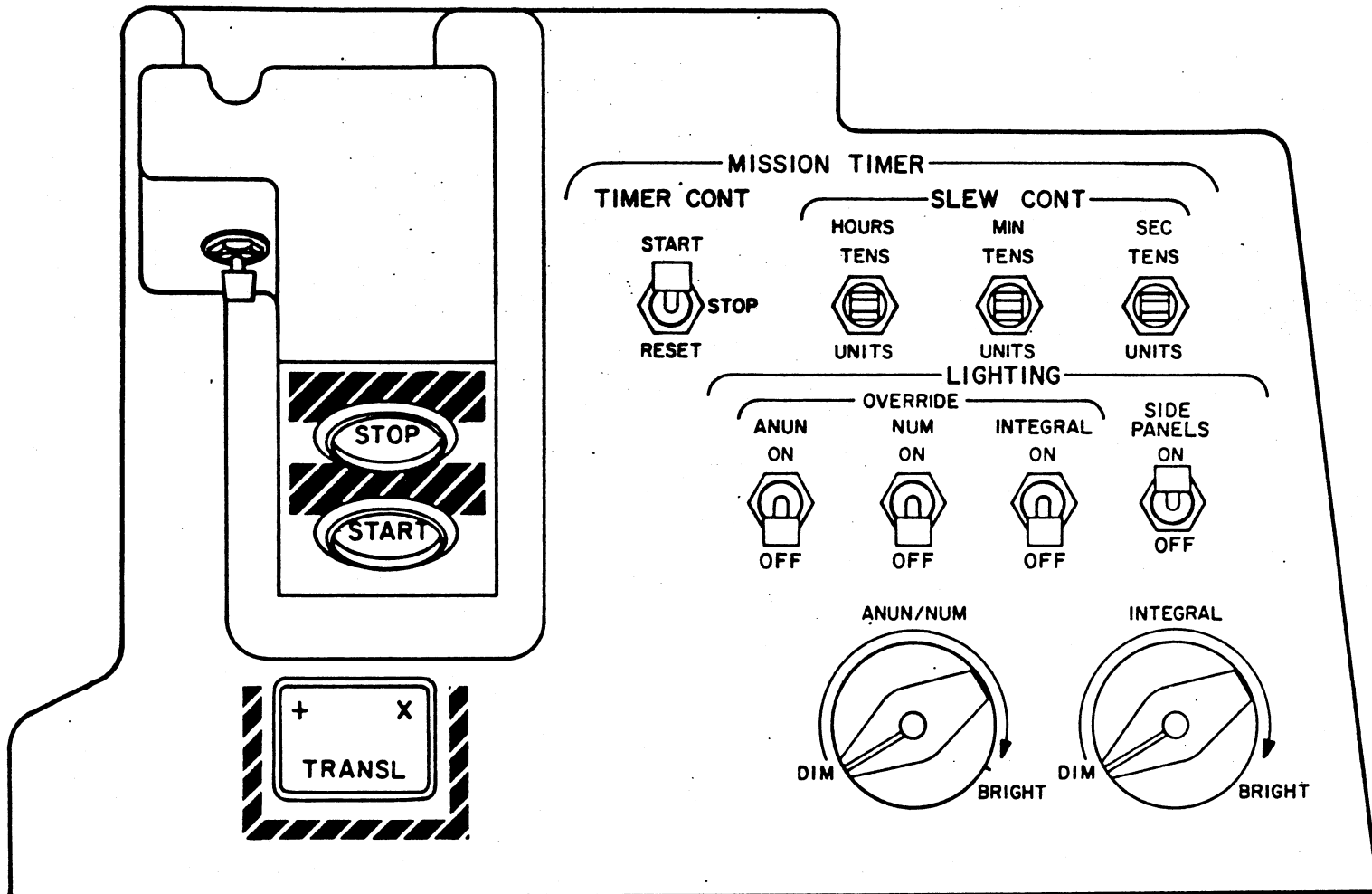

PANEL V  
LM 2

T30900-88  
APR 67

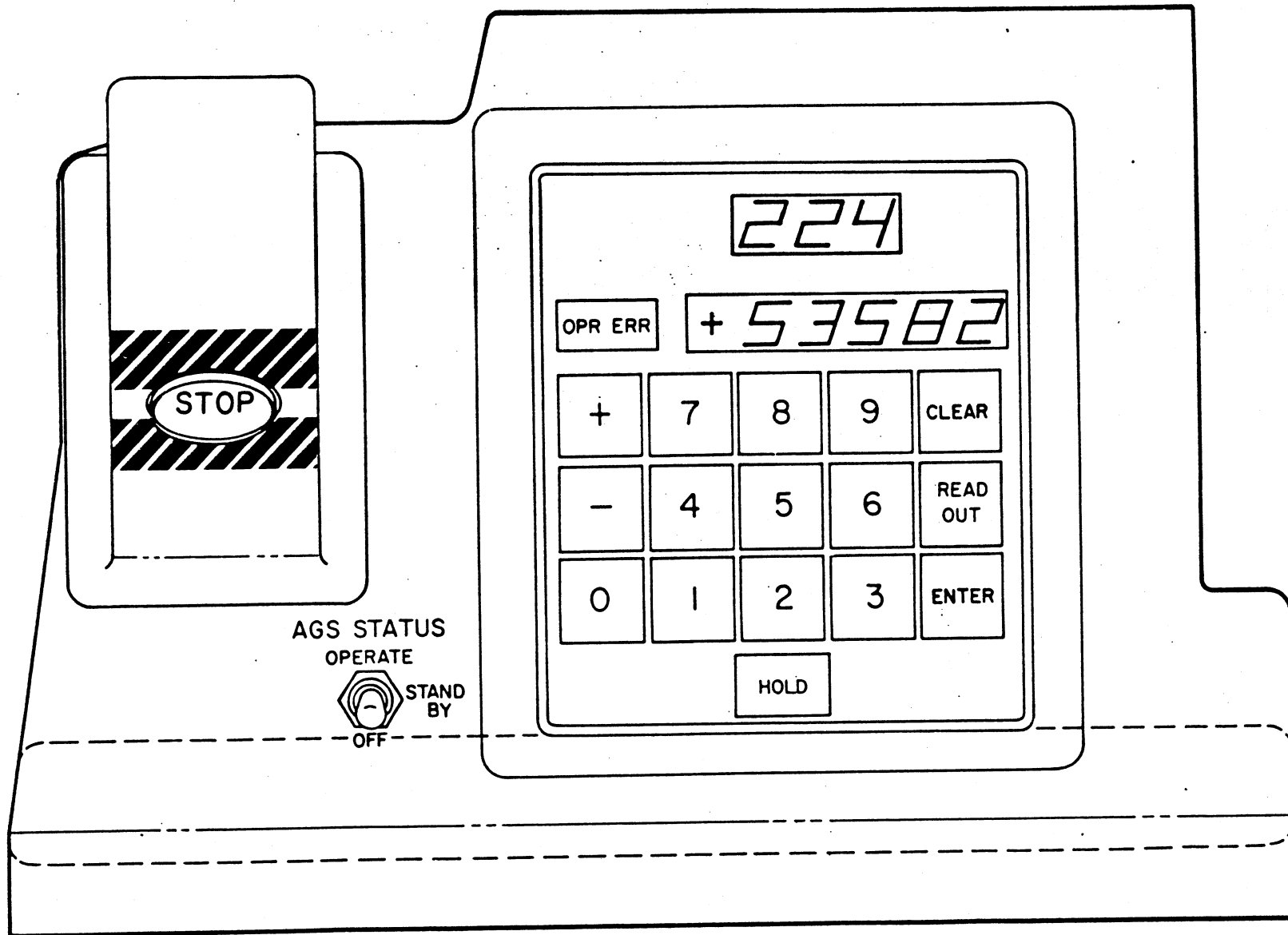

PANEL VI LM2 & SUB

T30900-89  
APR 67

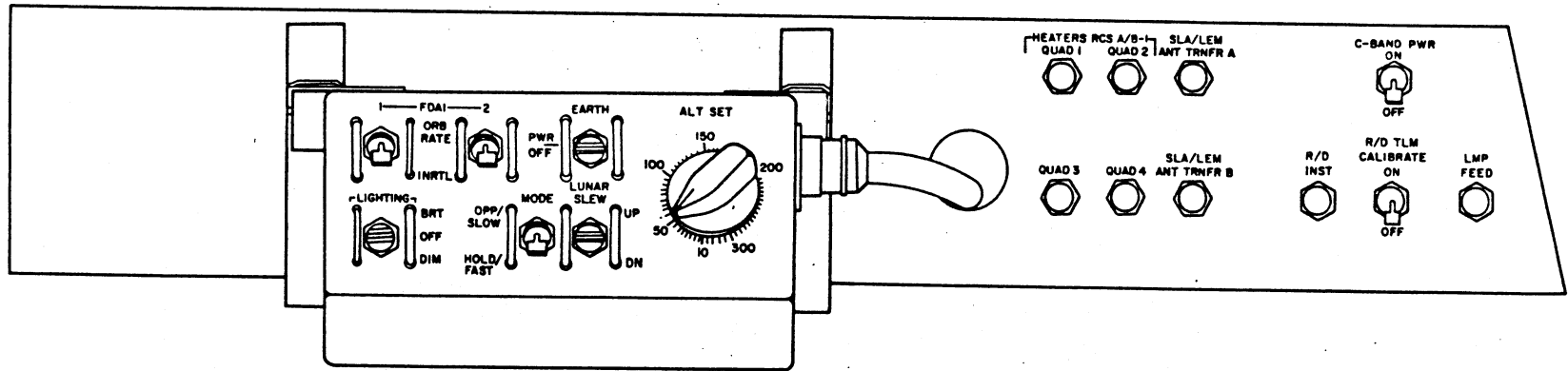

PANEL X  
LM-2

T30900-96  
APR 67

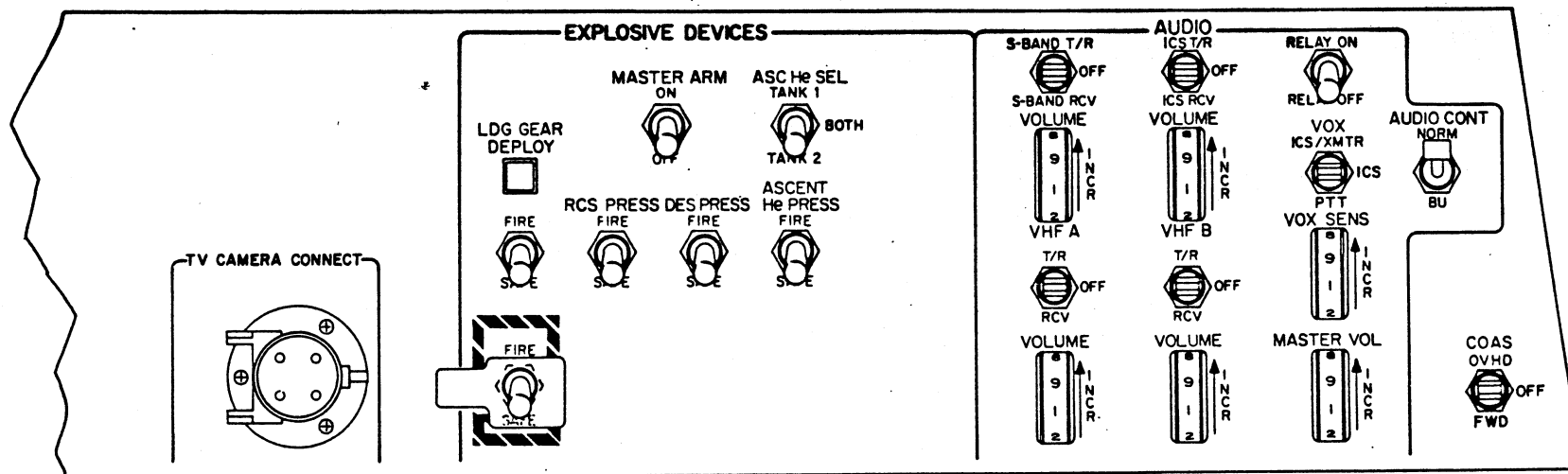

PANEL VIII  
LM2

T30900-90  
APR 67

7-A

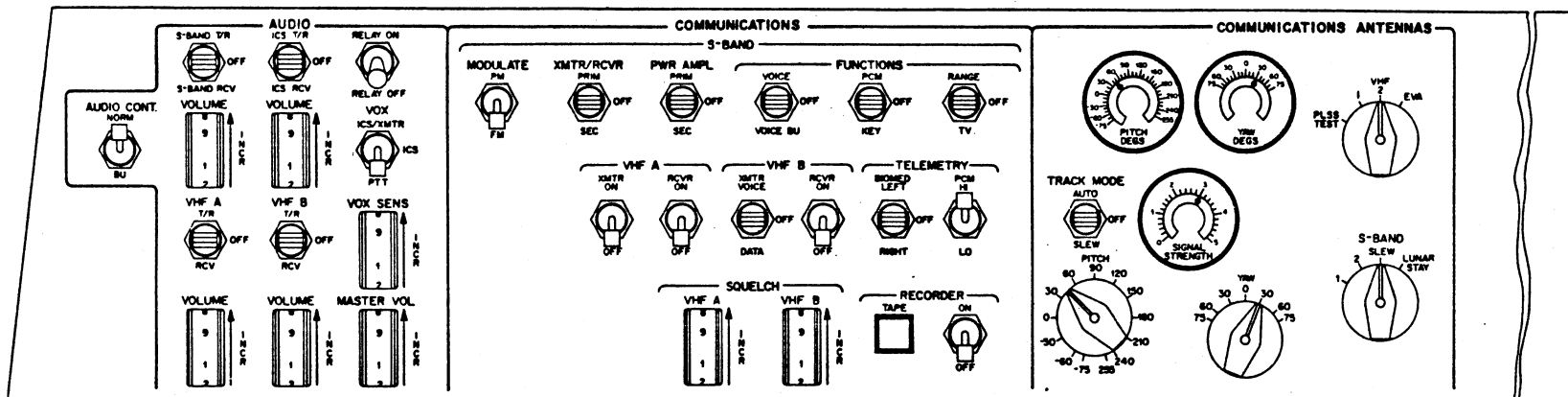

PANEL XII  
LM2

T30900-91  
APR 67

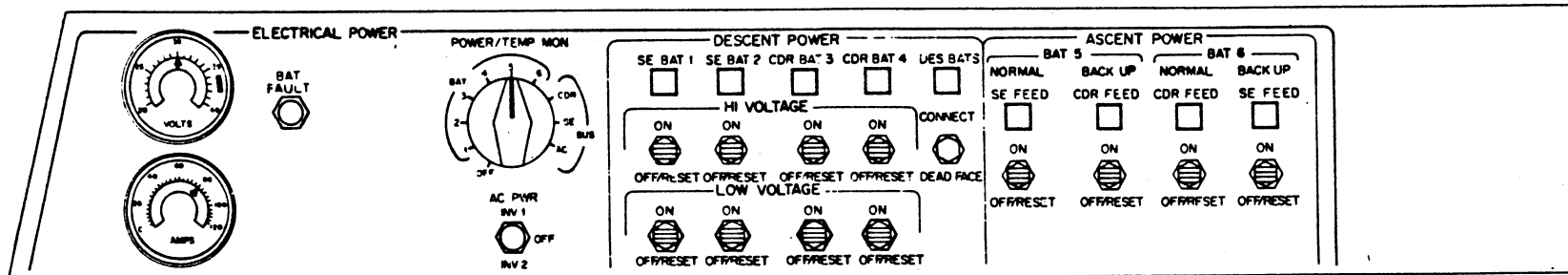

PANEL XIV LM2

T30900-92  
APR 67



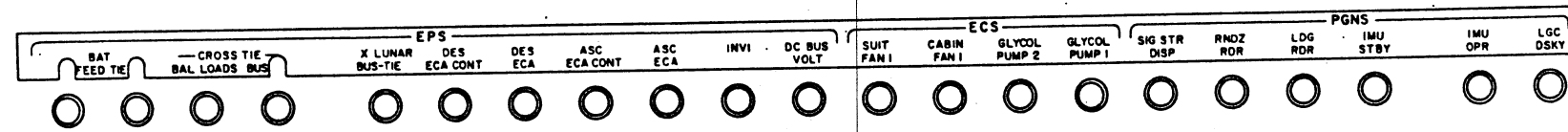
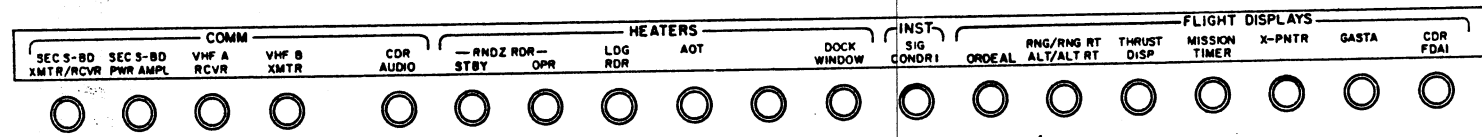
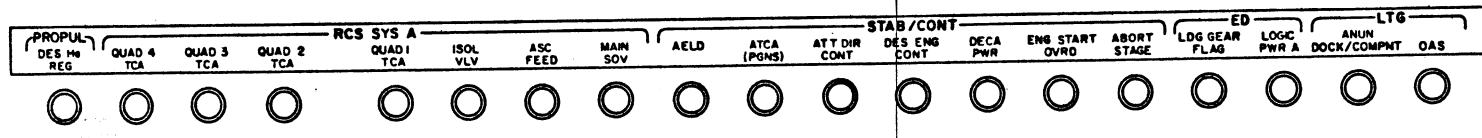
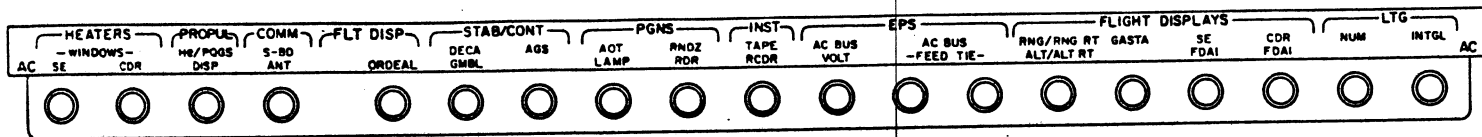

PANEL XI  
LM2

T30900-94  
APR 67

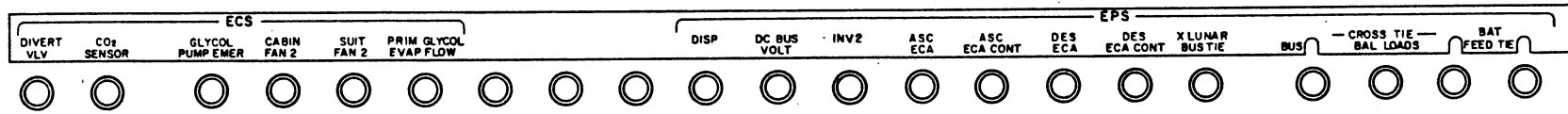
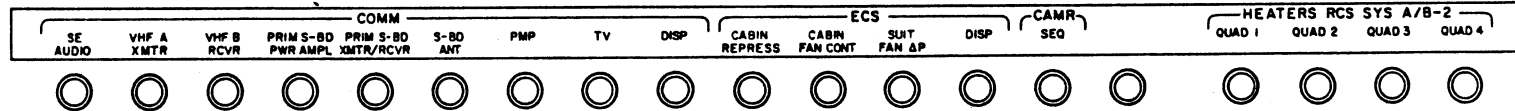
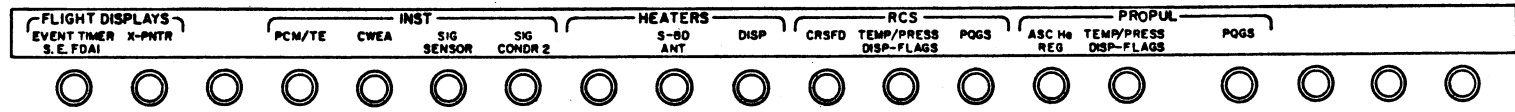
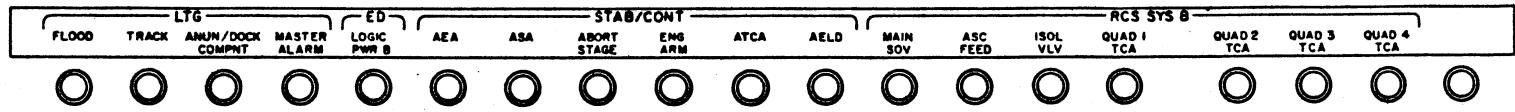

PANEL XVI  
LM2

T30900-95  
APR 67

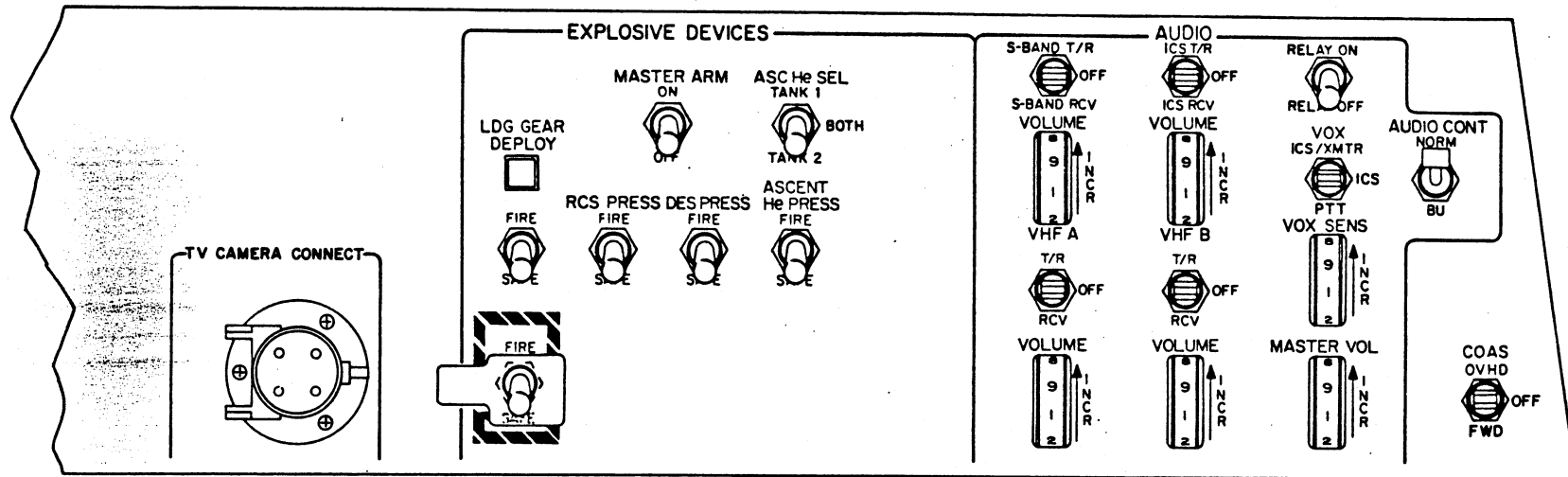

PANEL VIII  
LM2

T30900-90  
APR 67

6-7

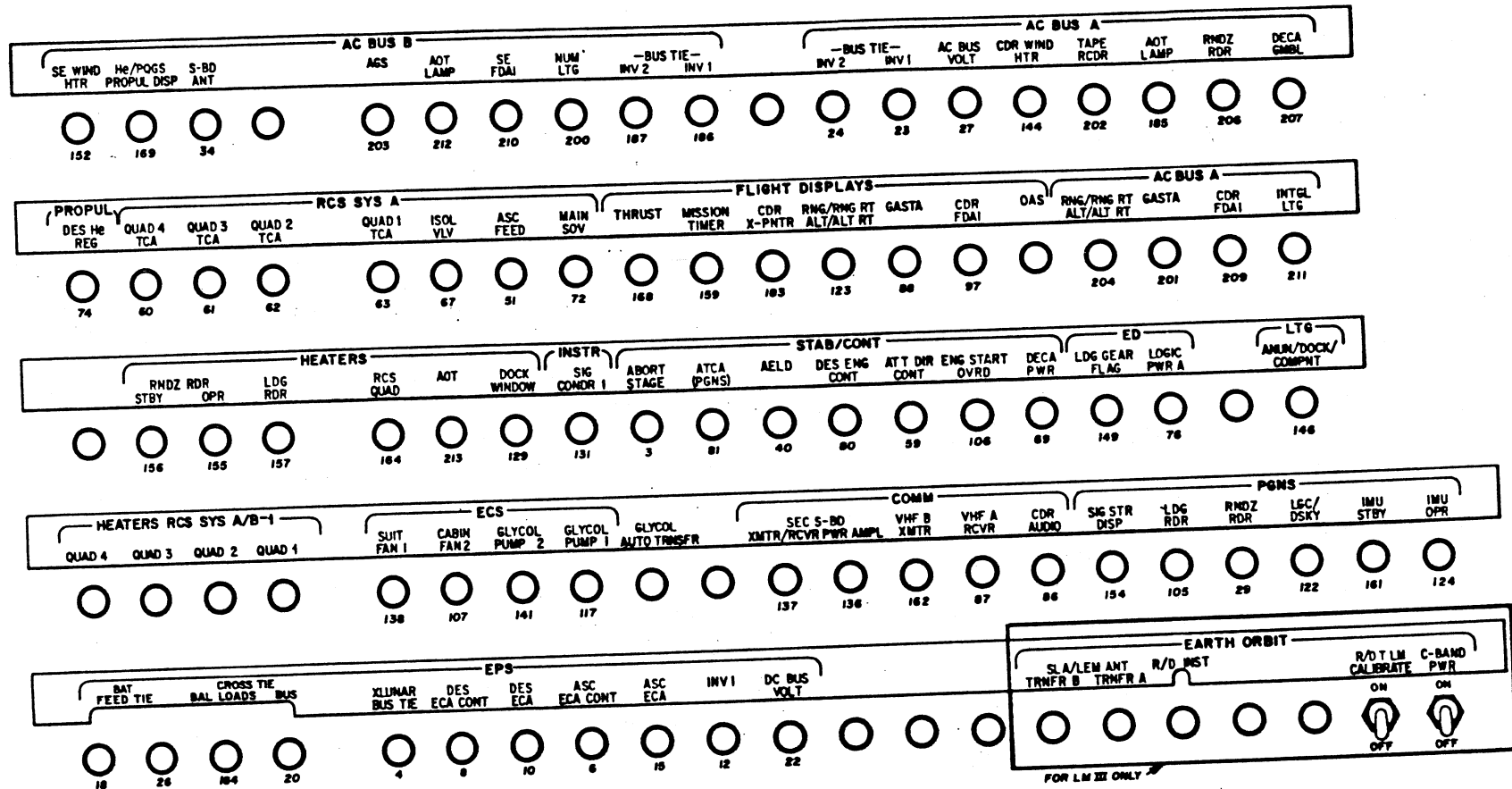
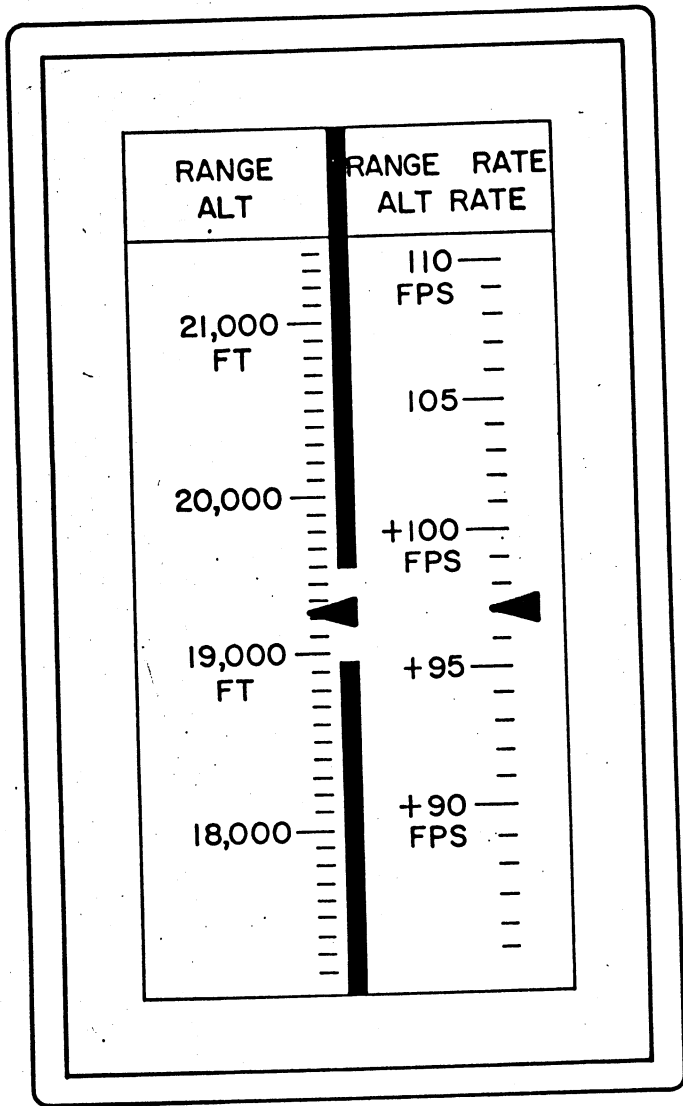

FIGURE 6-6. COMMANDER'S CIRCUIT BREAKER (PL XI)



ALTITUDE / RANGE INDICATOR 9M9

T30405-112  
MAY 66

115

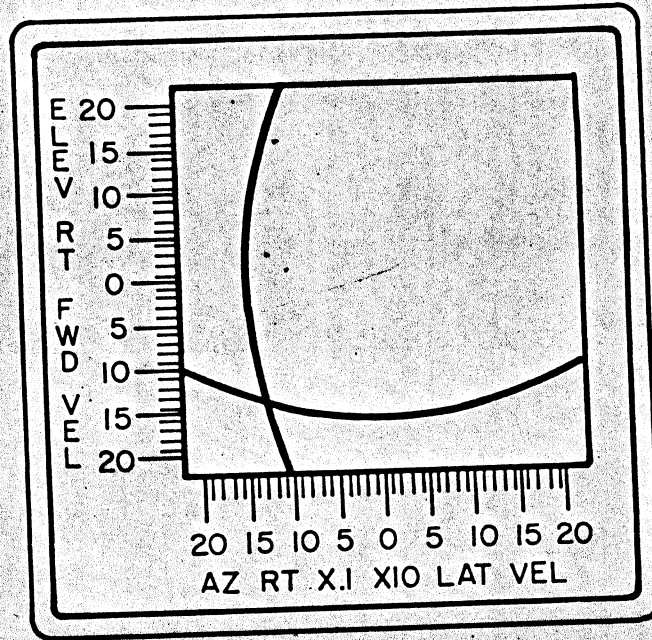

X-Pointer Indicator  
9M2 AND 9M3

T30405-96  
MAY 66

FIG. 4-3

116

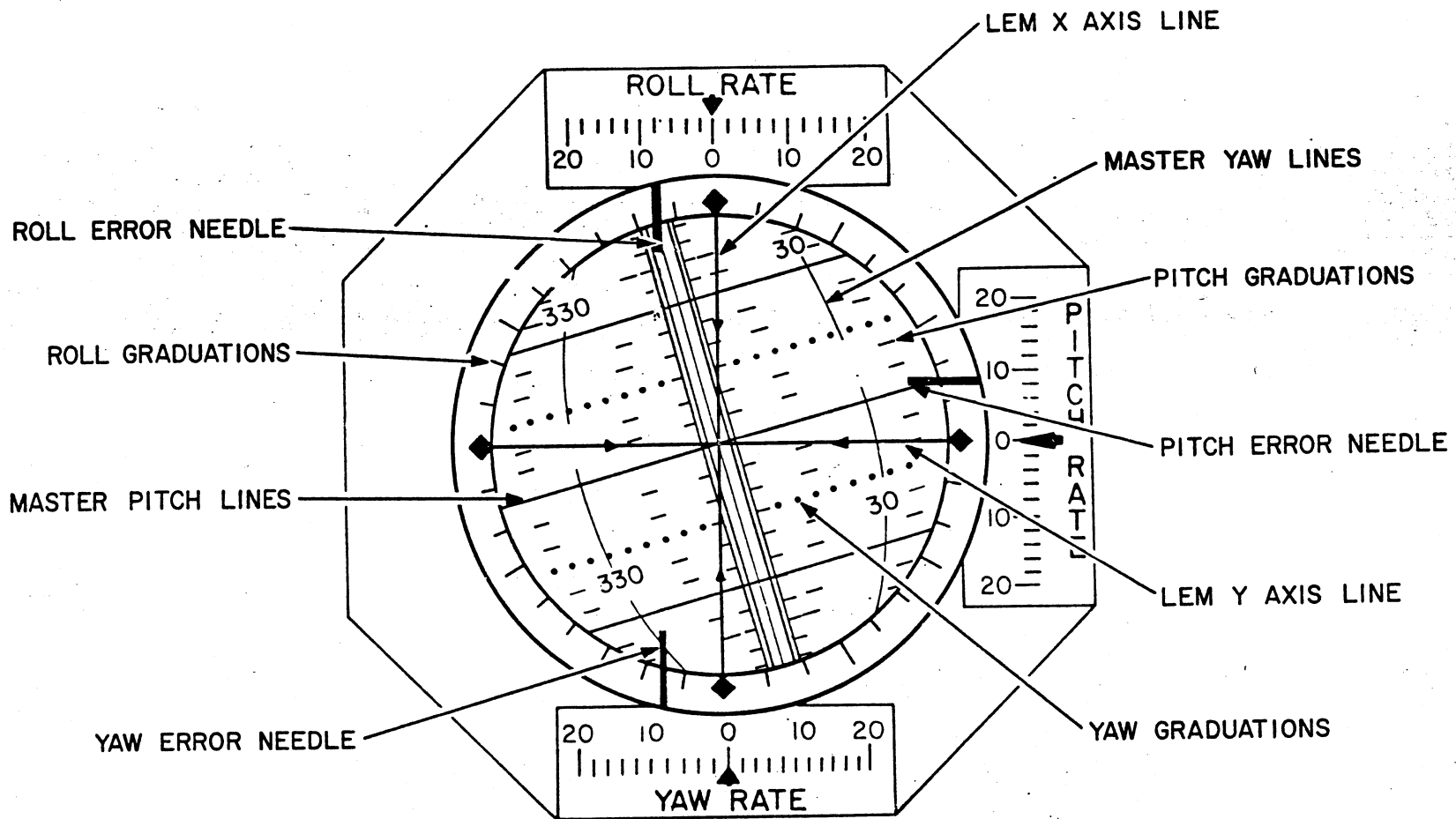

FLIGHT DIRECTOR ATTITUDE INDICATOR  
9MI & 9M6

T30405-85  
APRIL 66

Fig. 4-11



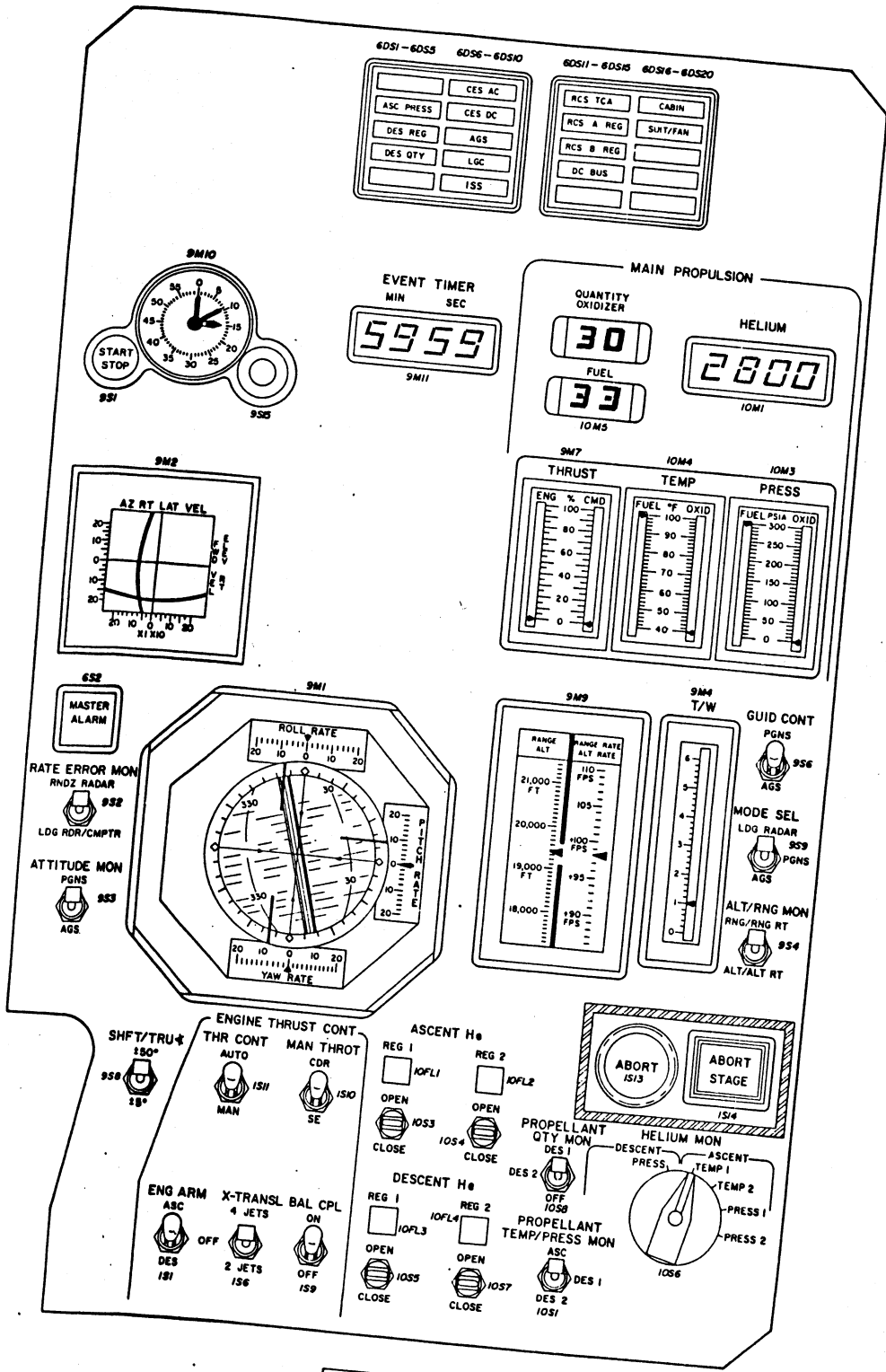

PANEL I

T30900-1  
FEB 66

Fig. 4-5

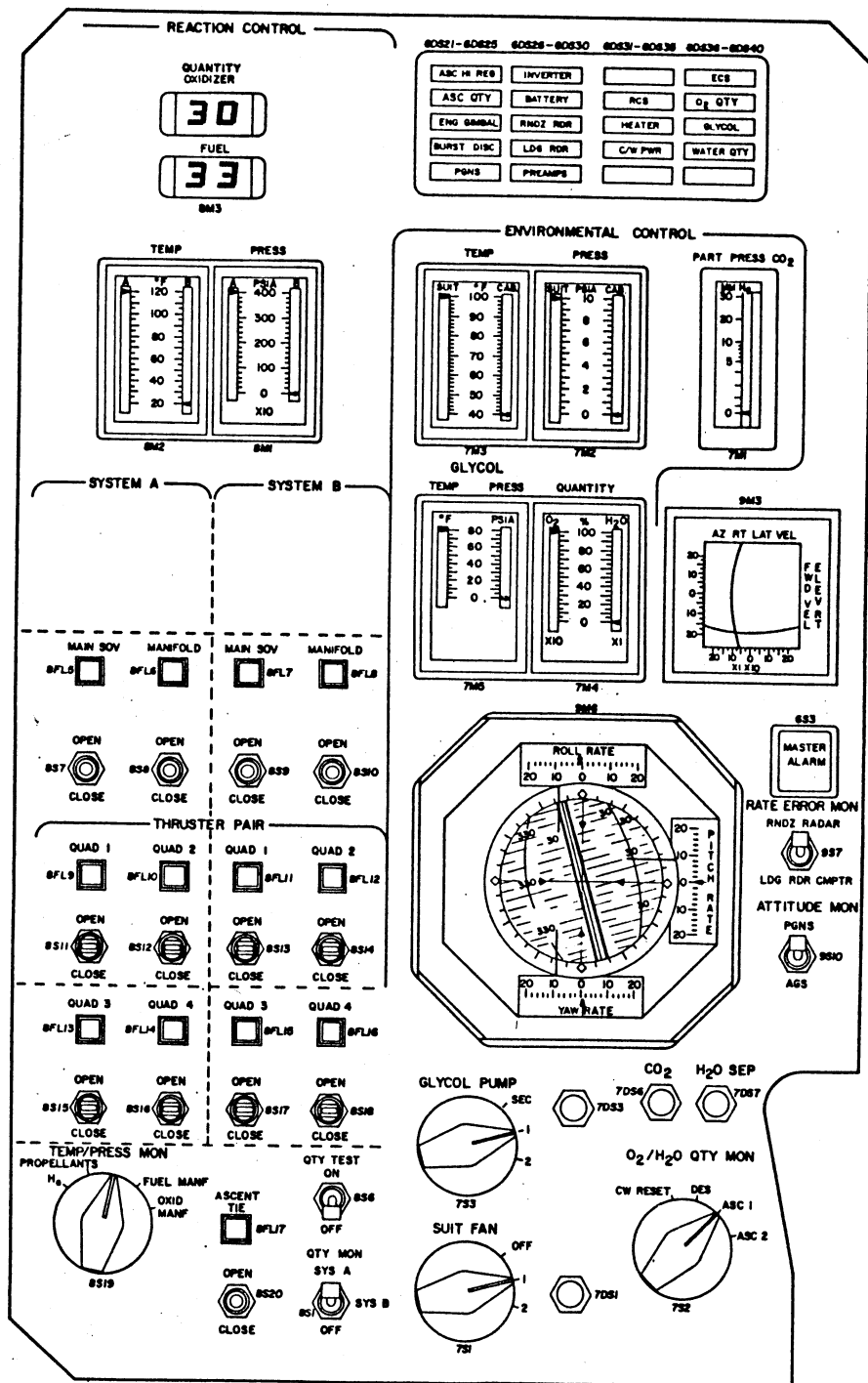

PANEL II

T30900-2  
FEB 66

119

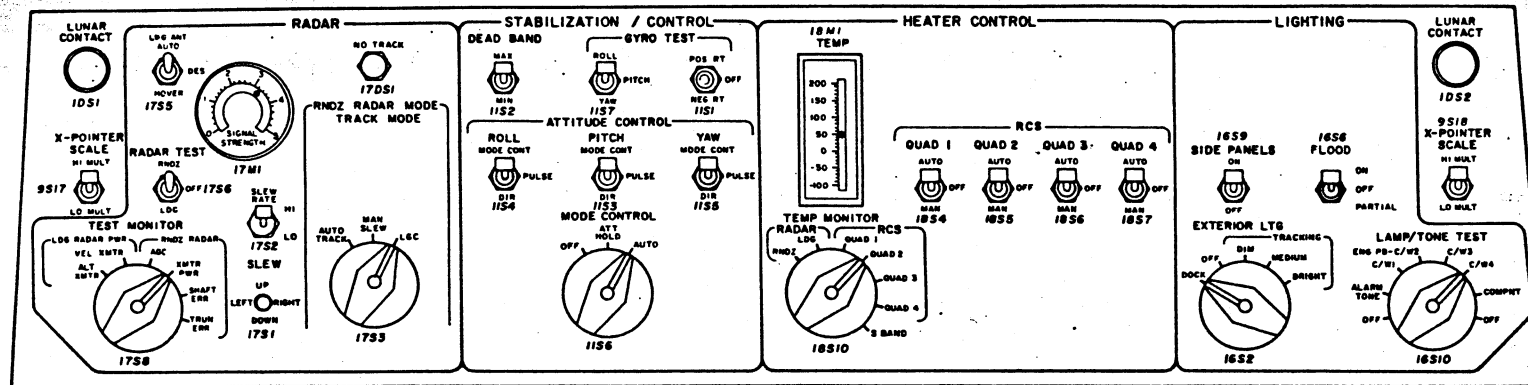

PANEL III

T30900-3  
FEB 66

Fig. 4-7

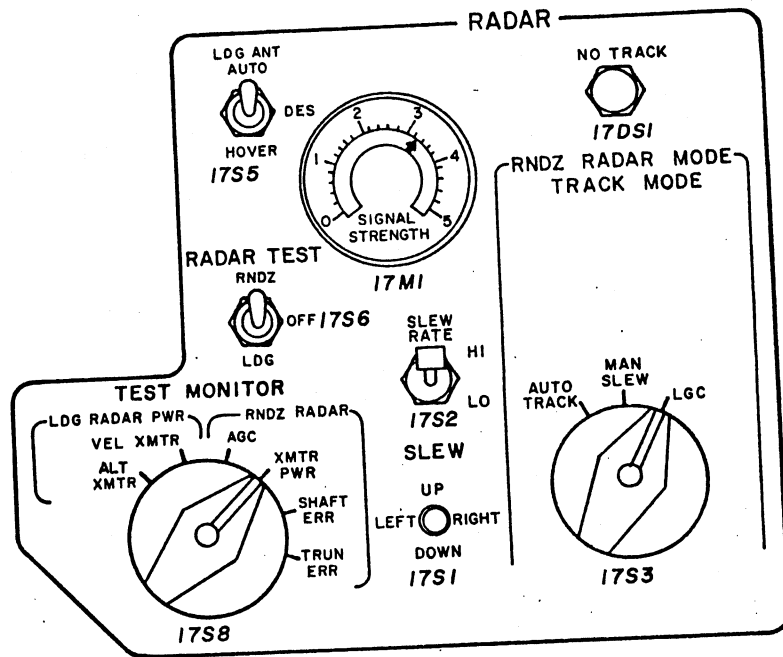

RADAR PANEL (PART OF PANEL III)

T30405-11  
MAY 66

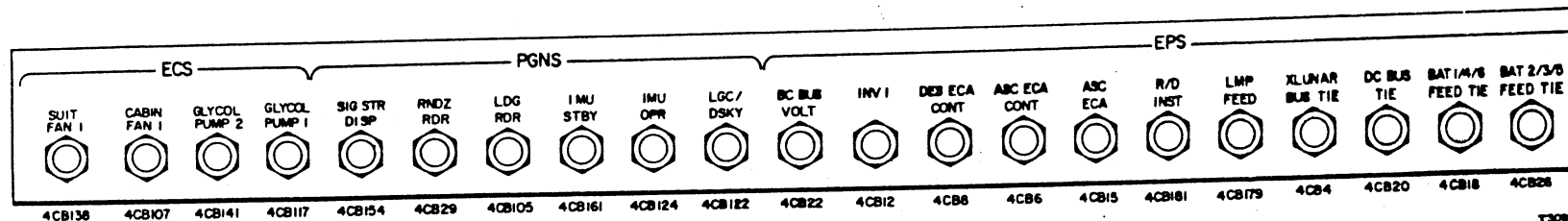
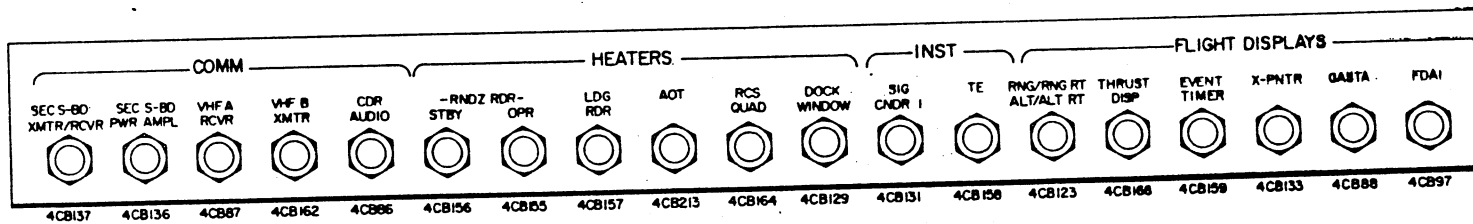
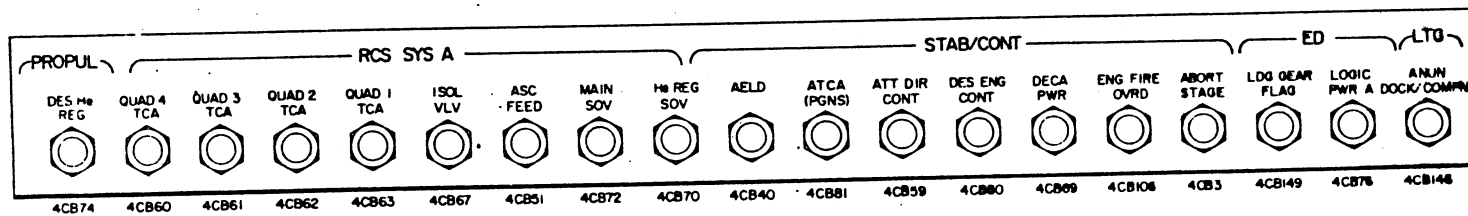
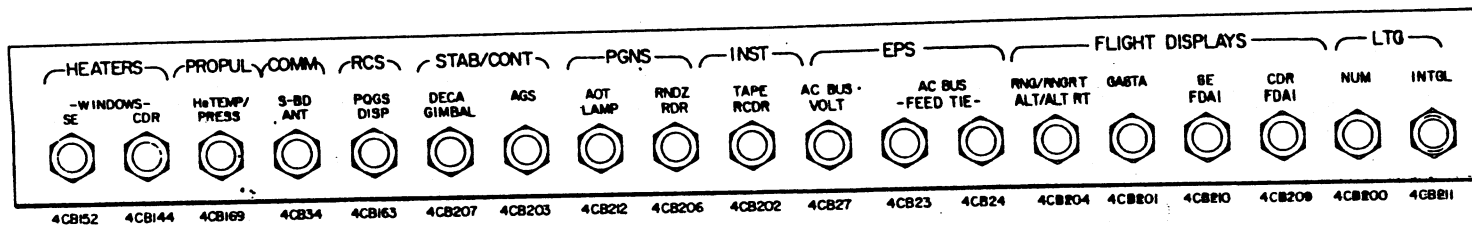

PANEL XI

T30800-80  
DEC 65

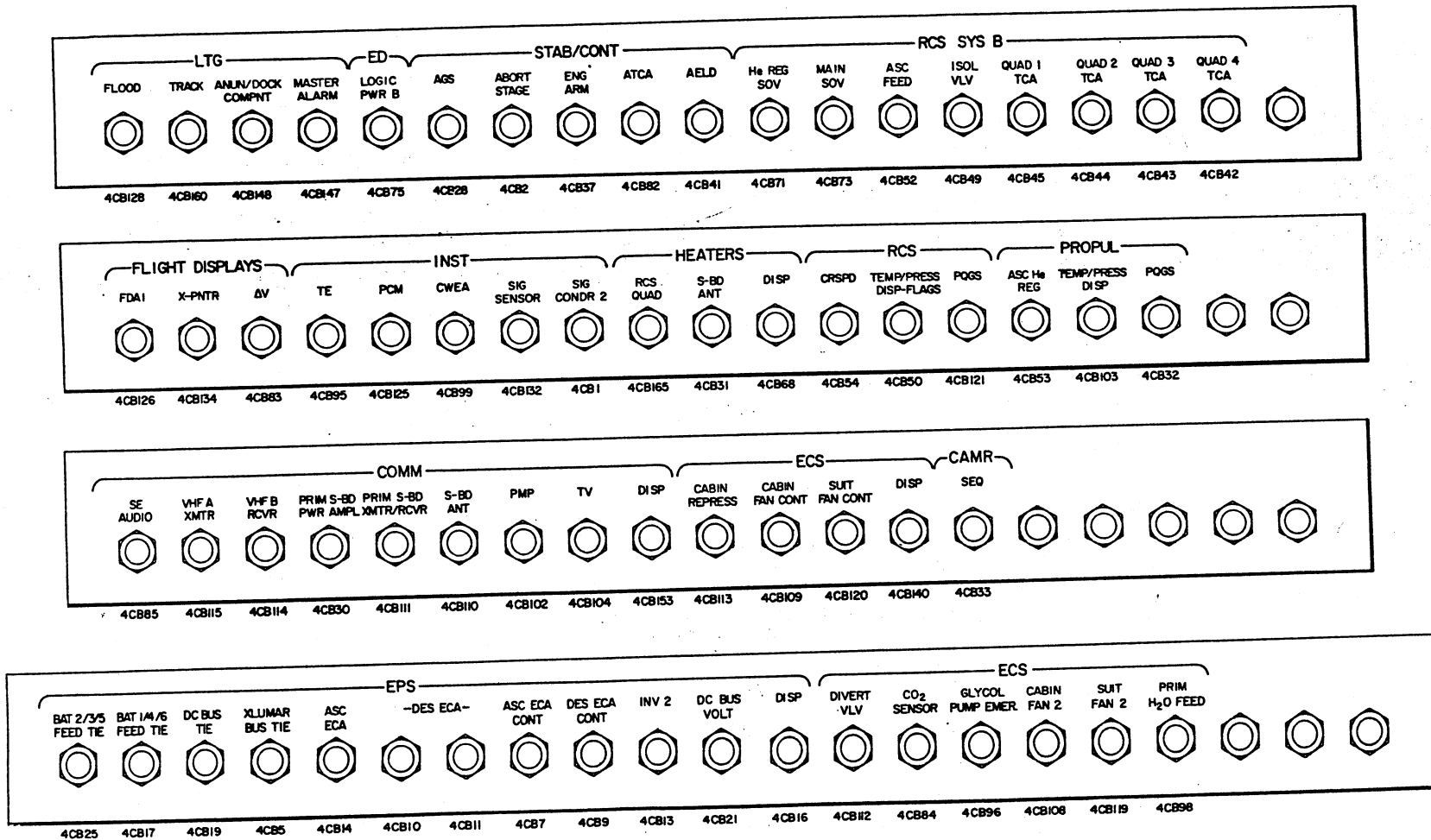

PANEL XVI

T30900-21  
DEC 65

123

FIG. 4-11

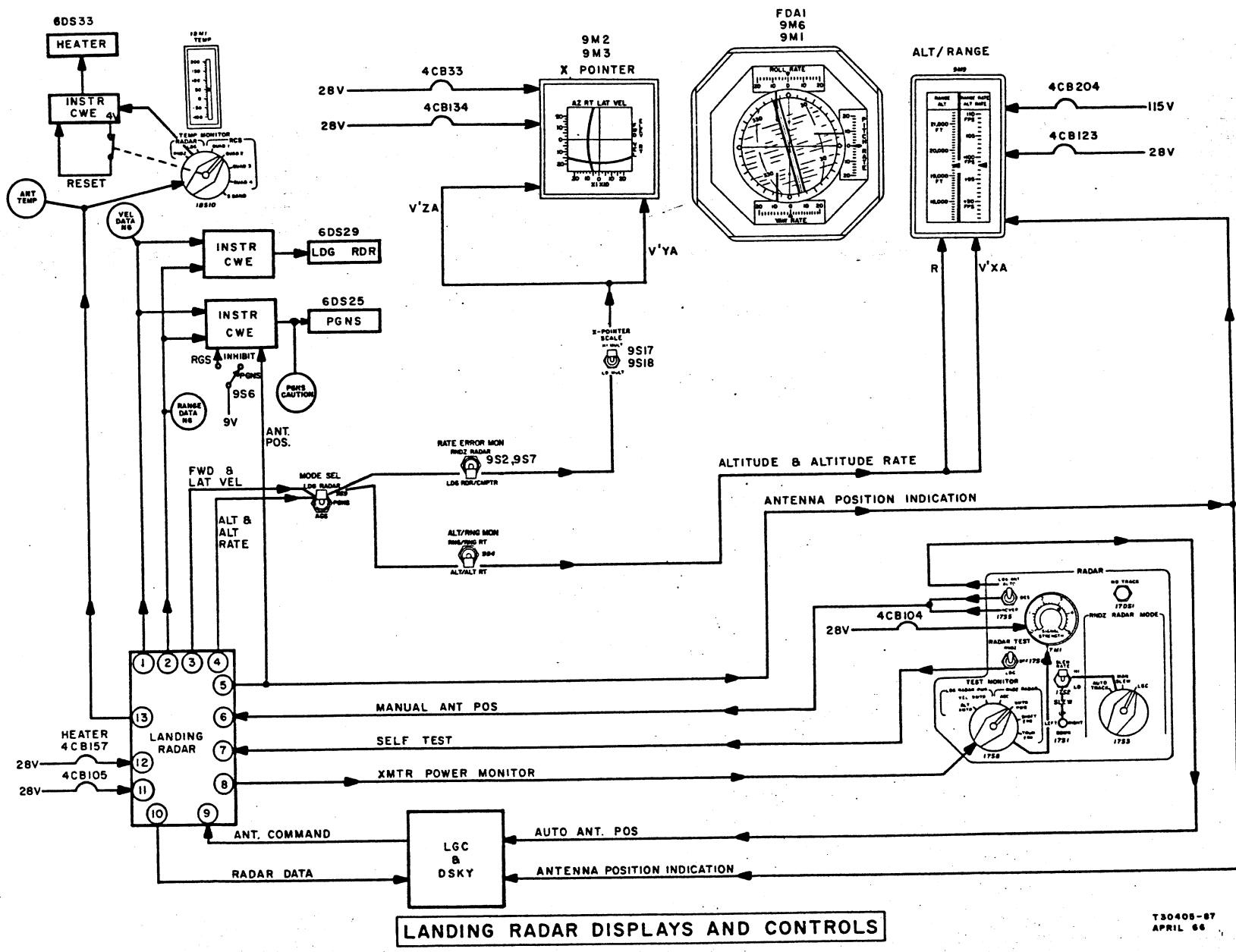

LANDING RADAR DISPLAYS AND CONTROLS

T30405-87  
APRIL 66



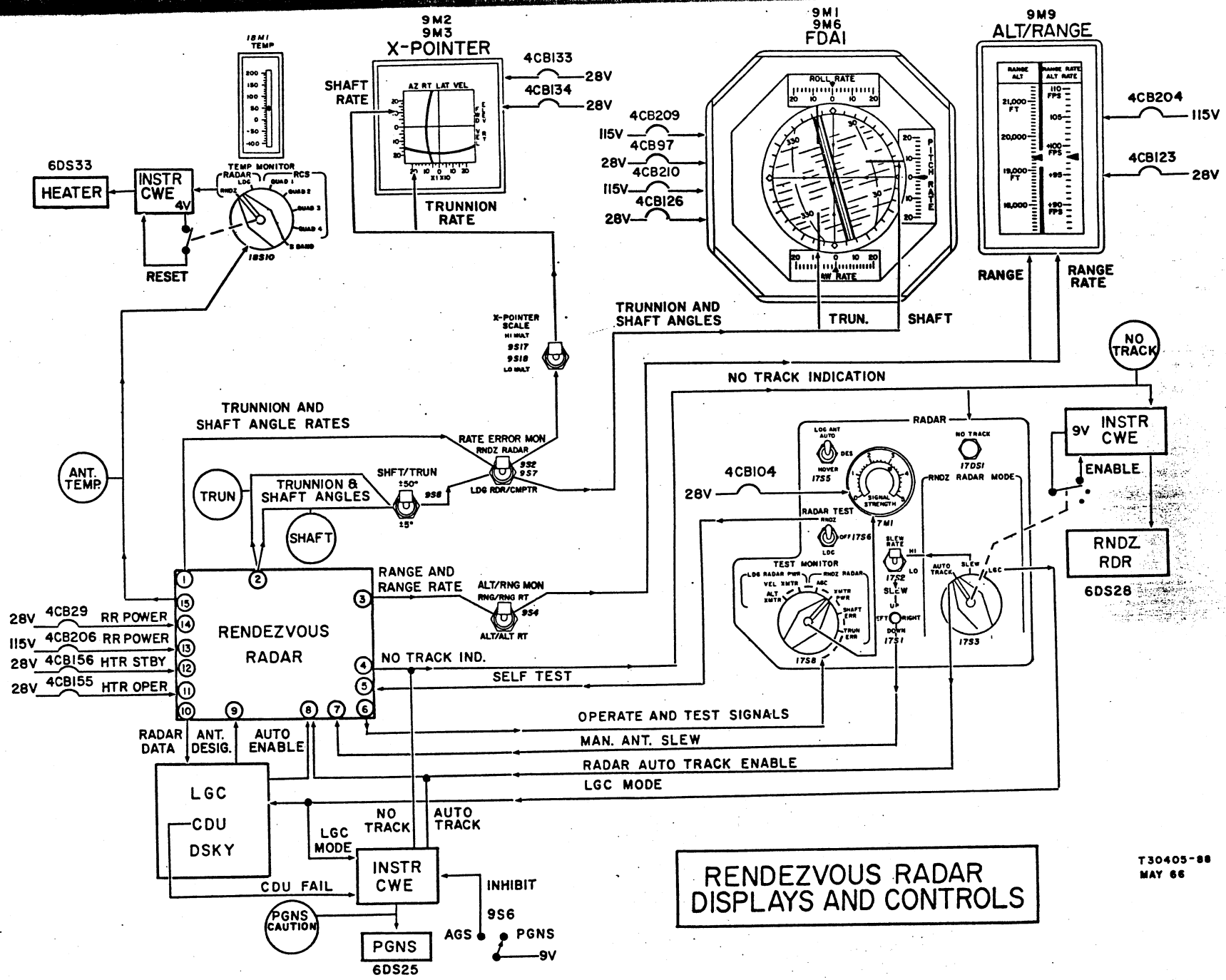

**RENDEZVOUS RADAR DISPLAYS AND CONTROLS**

T30405-88  
MAY 66

124

Fig. 4-12

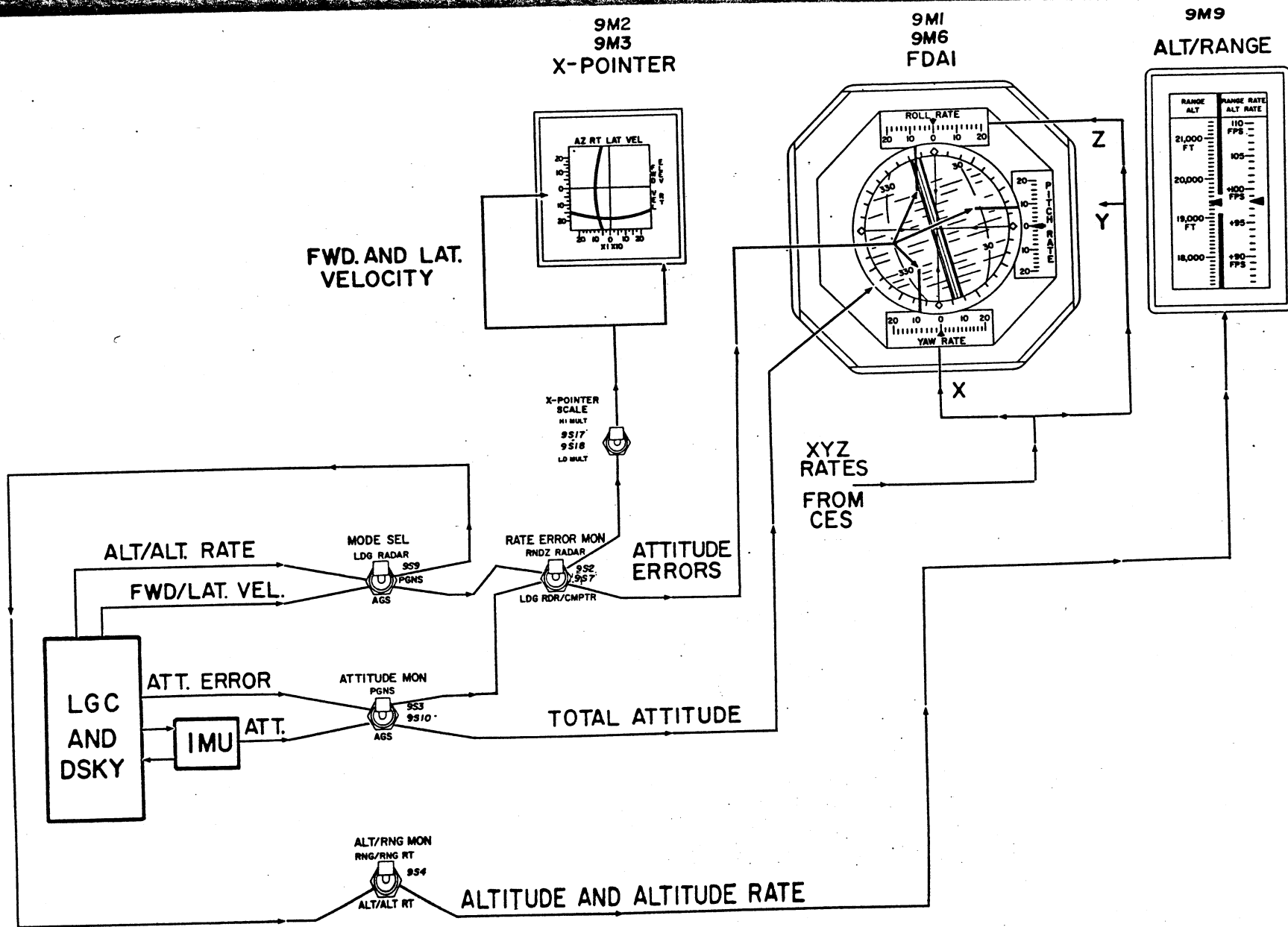

**PGNS DISPLAYS AND CONTROLS**

T30405 - 89  
MAY 66

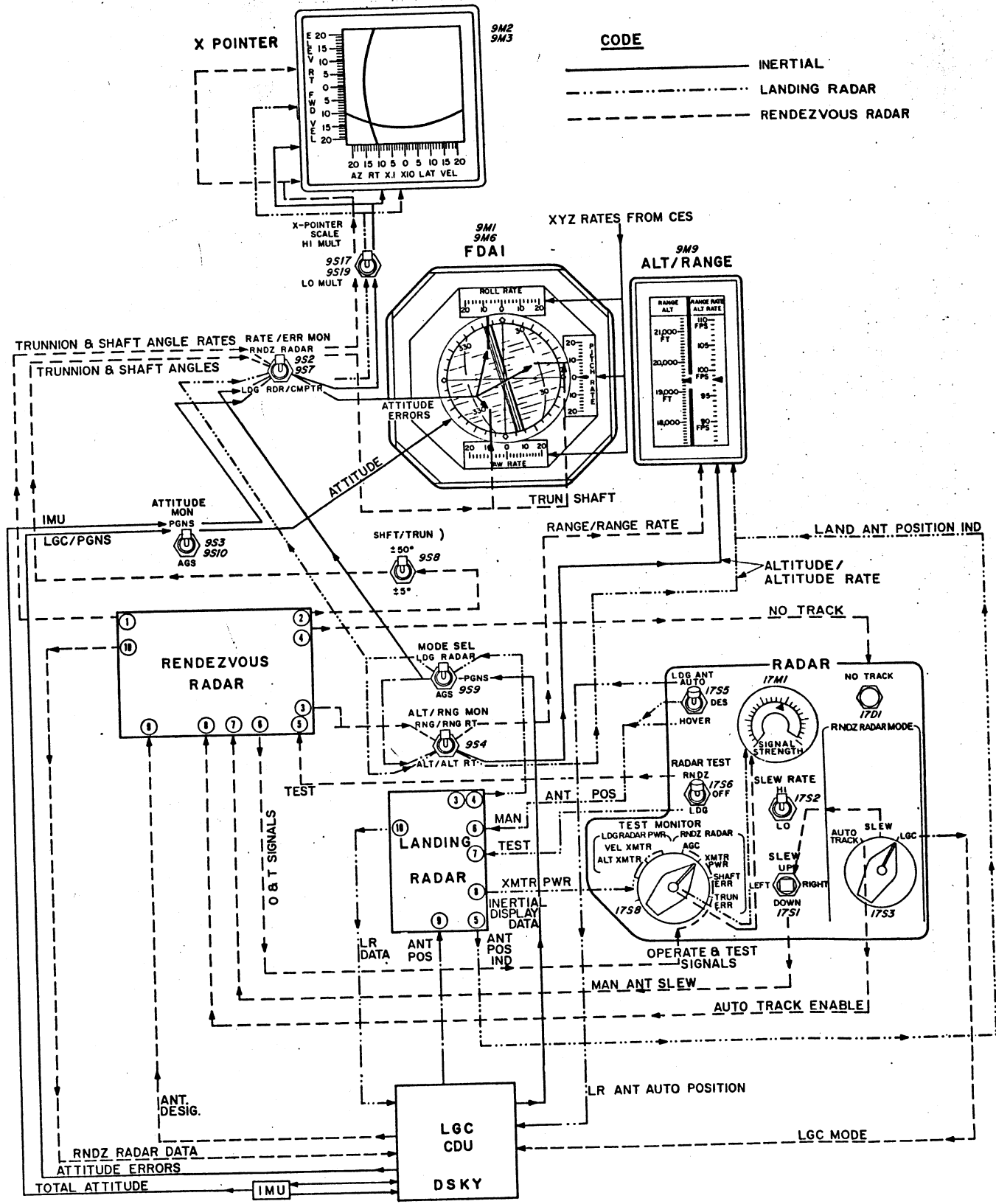

**FUNCTIONAL PGNS CONTROL DIAGRAM**

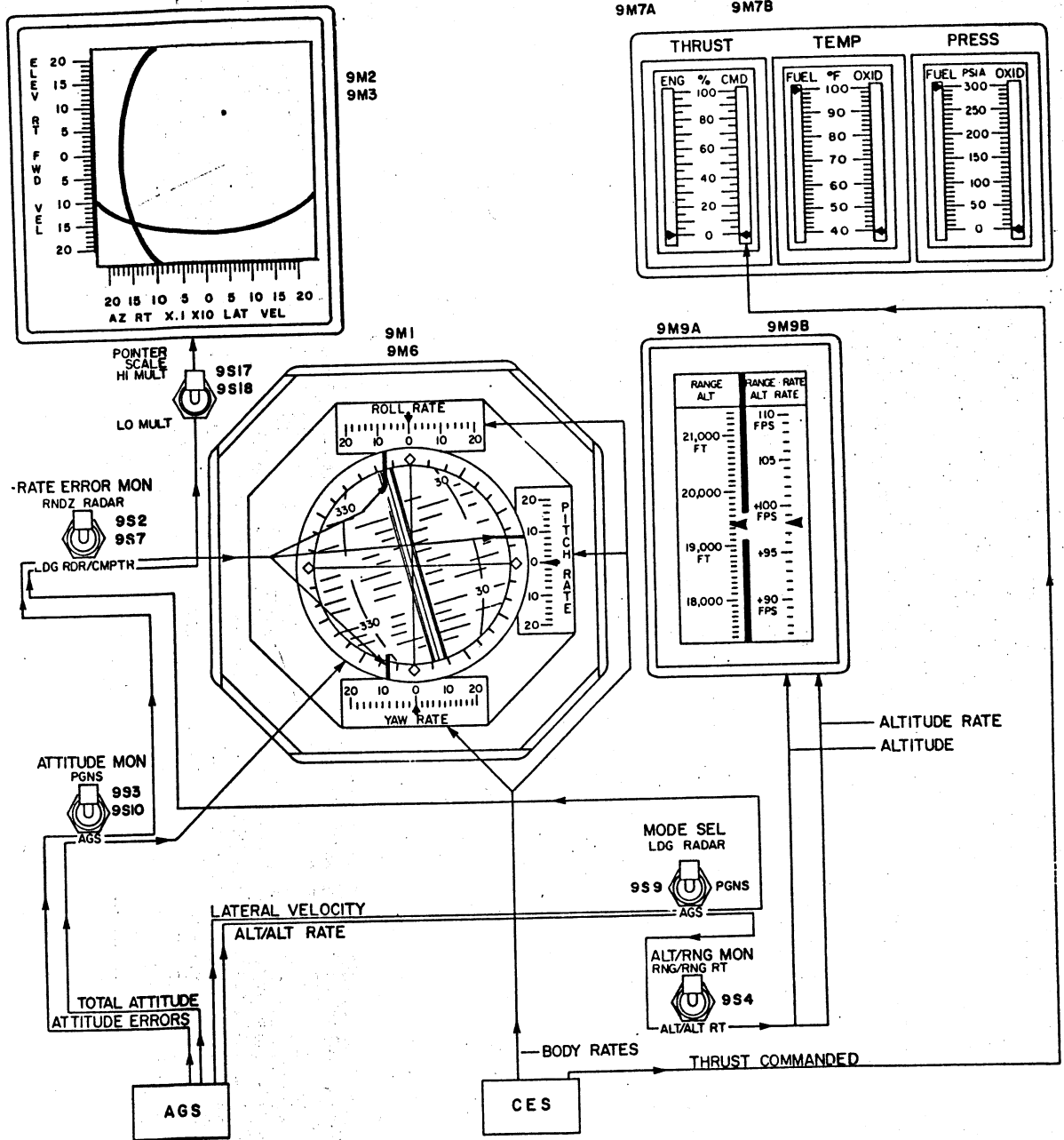

CES - AGS DISPLAYS AND CONTROLS

T30312-18  
MAY 66

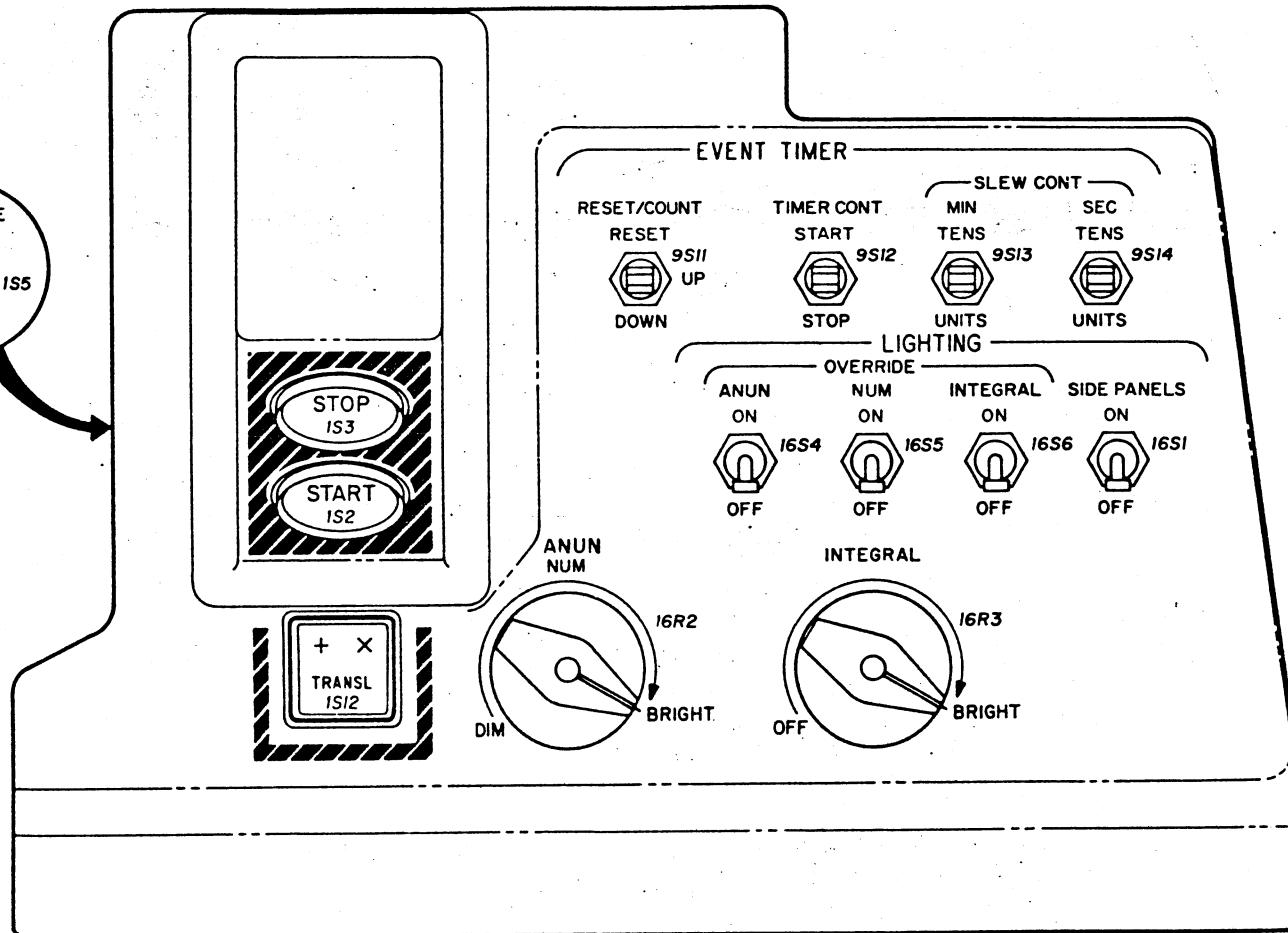

COMMANDER'S LIGHTING PANEL  
PANEL V

T30405-91  
APRIL 66

Fig. 4-16

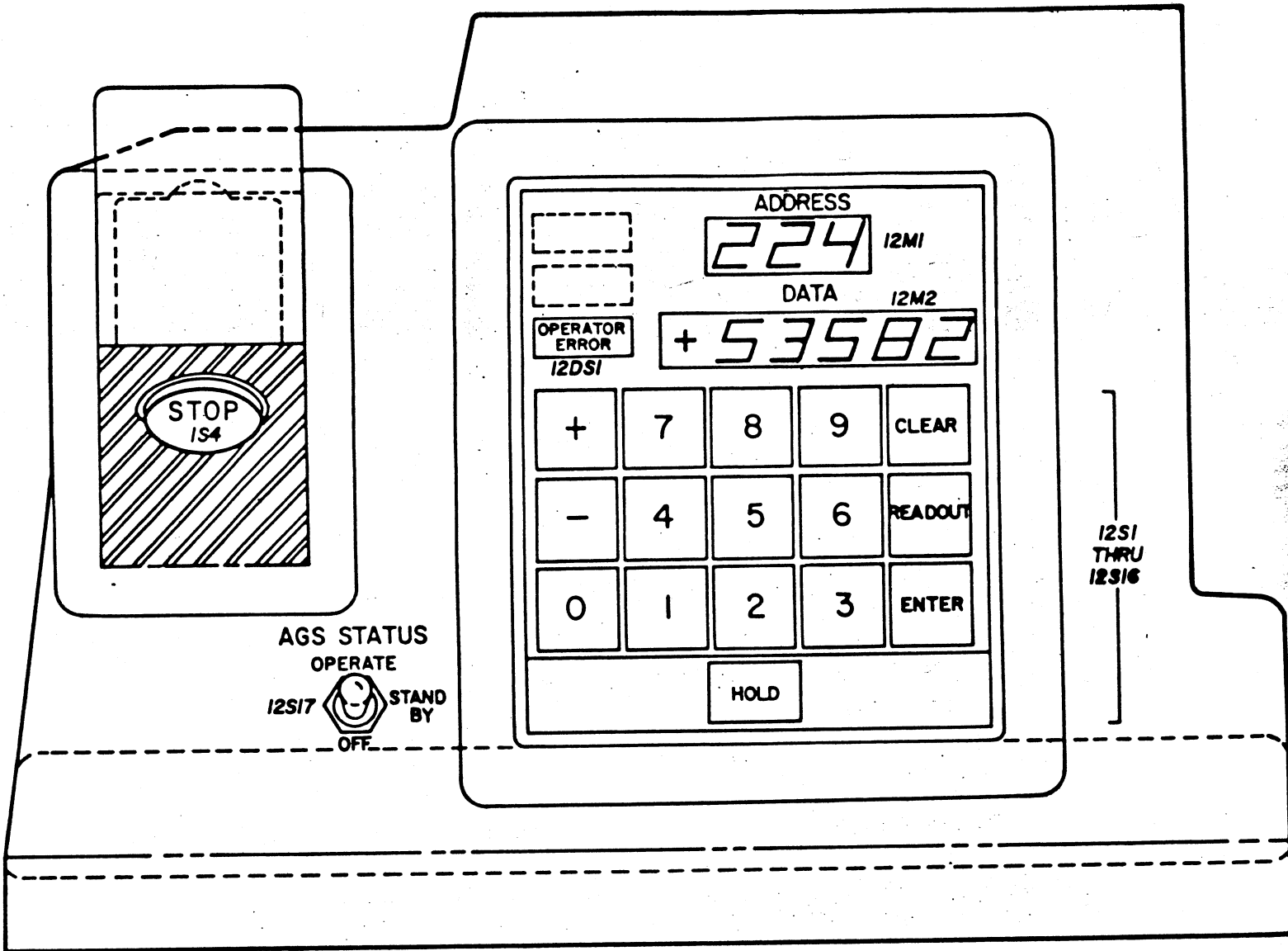

AGS STATUS  
OPERATE  
I2S17  STAND BY  
OFF

I2S1  
THRU  
I2S16

PANEL VI

T30900-5  
AUG 65

FIG. 4-17

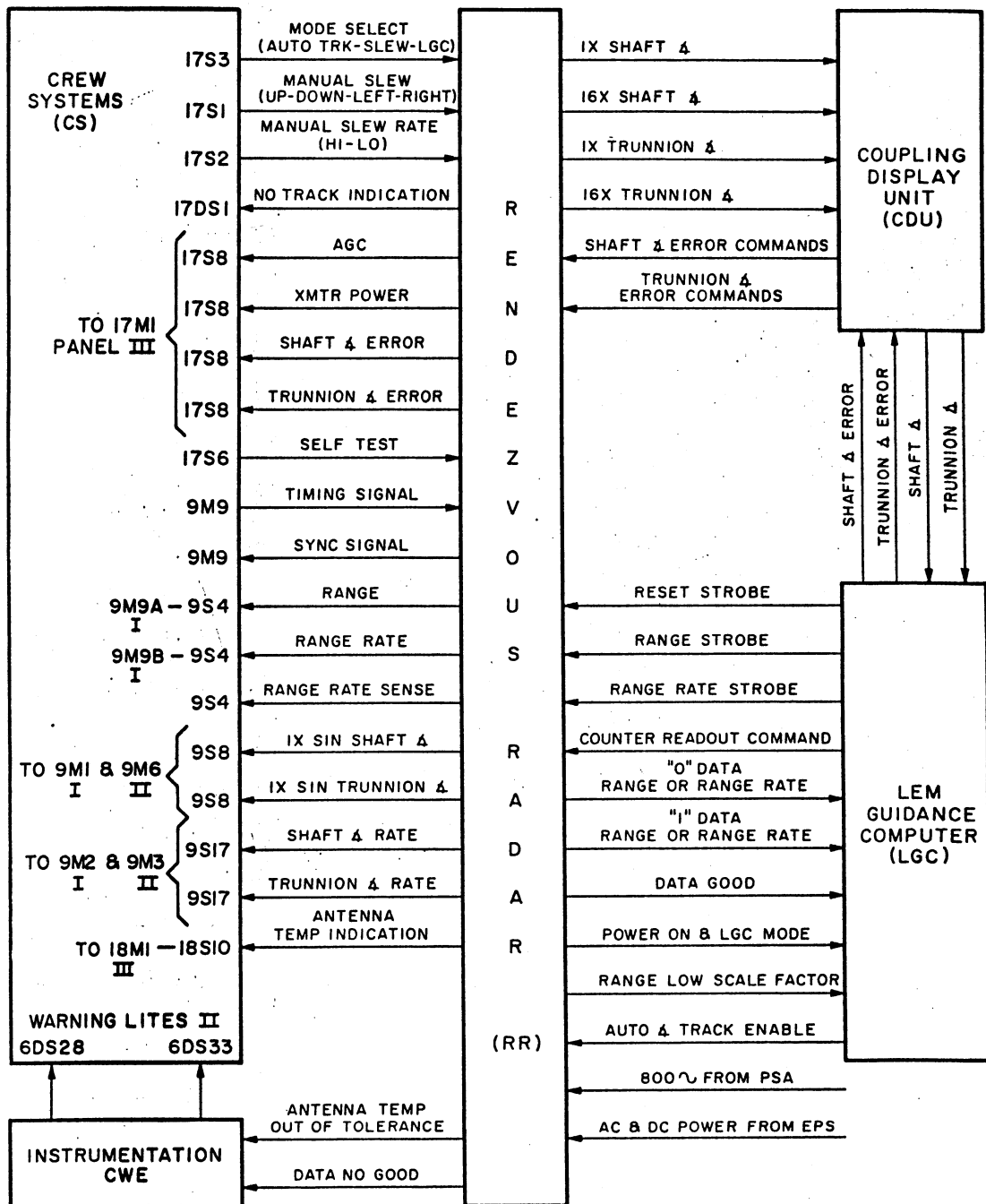

RENDEZVOUS RADAR INTERFACE

T30405-90  
APRIL 66



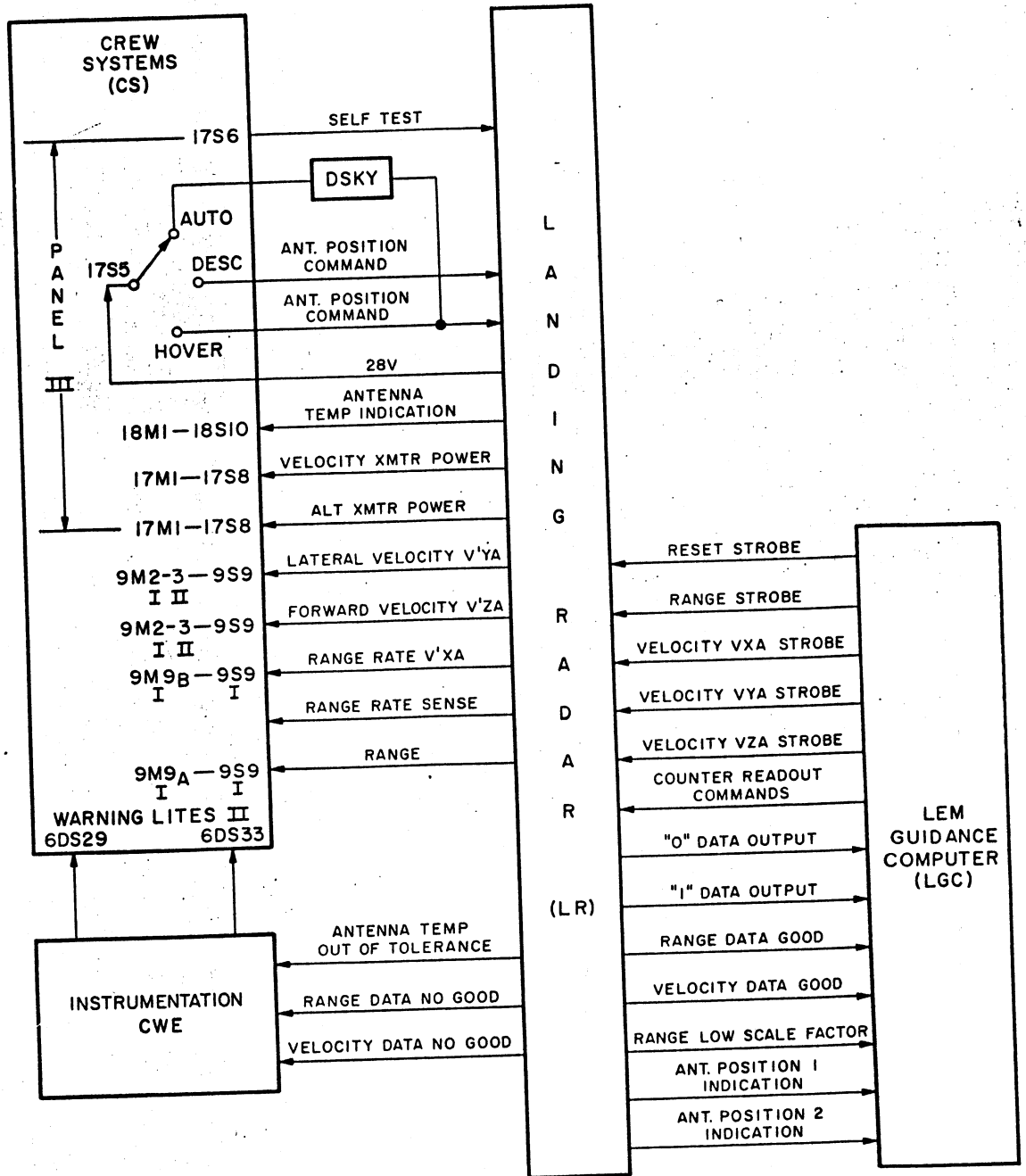

LANDING RADAR INTERFACE

T30405-92  
APRIL 66

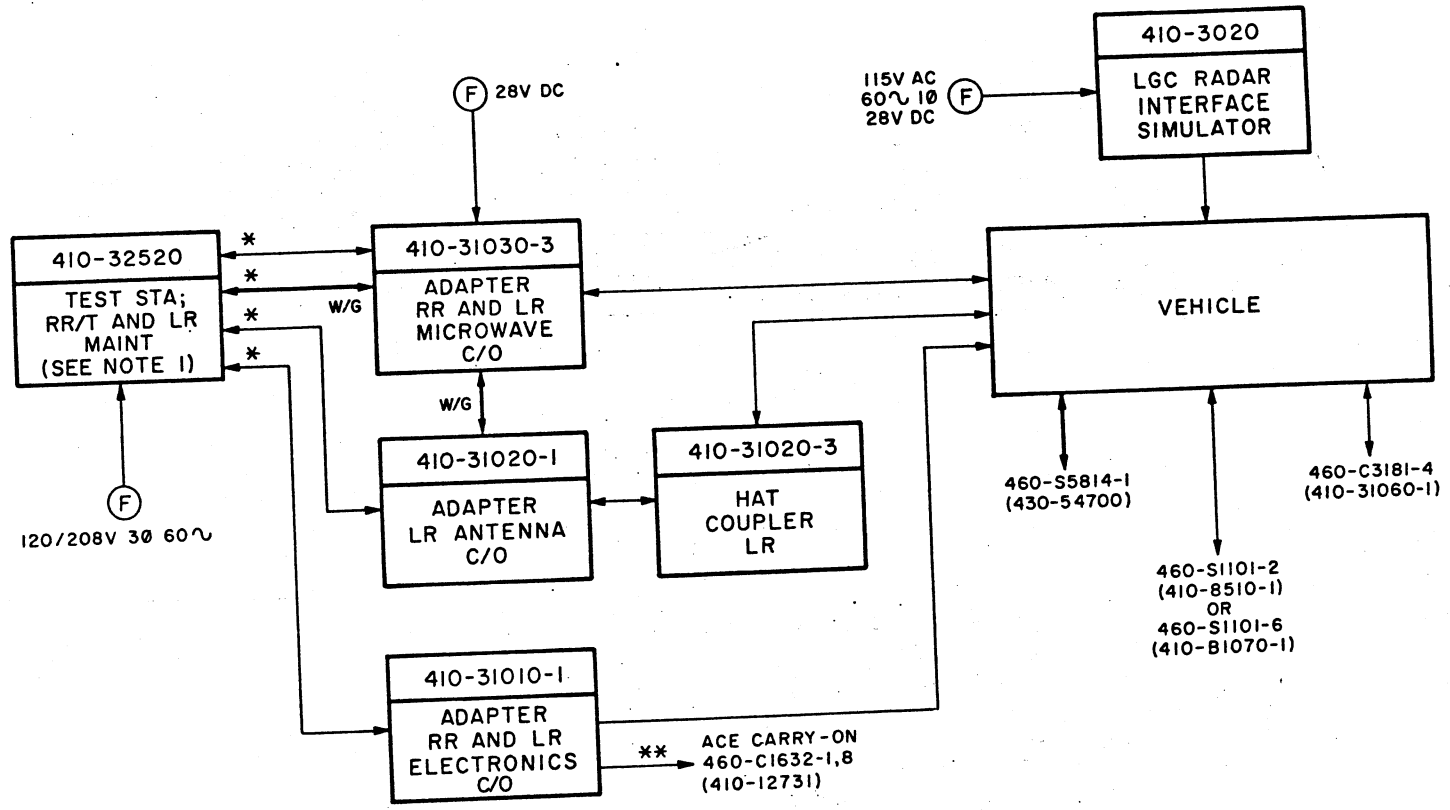

- NOTES:
1. USAGE: GAEC-7 HSCI-2  
-1 LTA-8, LEM 1-11
  2. MATED CONFIGURATION
  3. \* CABLE SET 410-11190-1
  4. \*\* CABLE SET 410-11170-1 FOR HSCI-2  
410-11170-3 FOR LTA-8  
410-11170-5 FOR LEM-1

**RADAR-GSE CHECKOUT - GAEC CONFIGURATION**

T30405-93  
APRIL 66

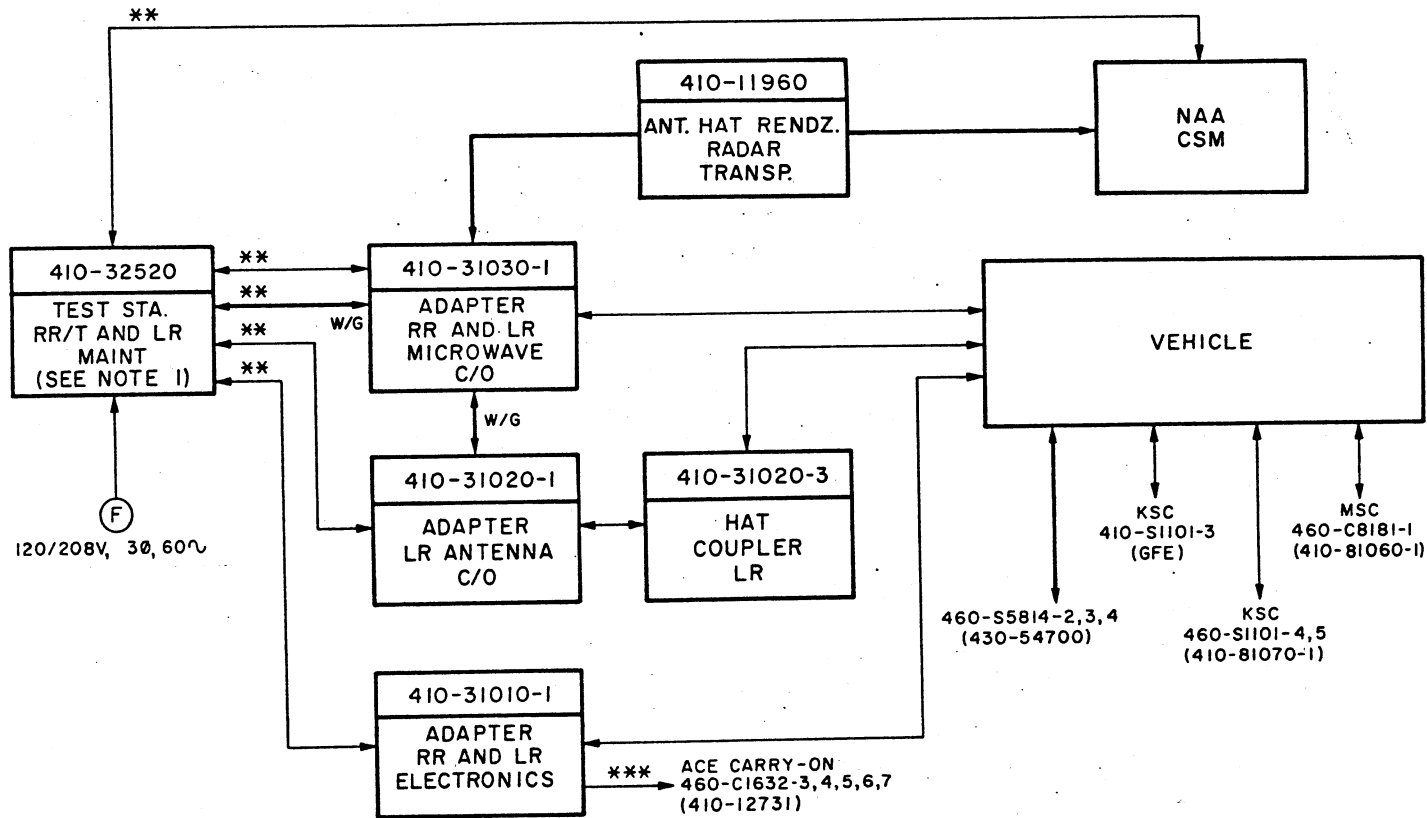

NOTES:

1. USAGE : MSC-LTA-8 (410-32520-5)  
KSC-LEM-I THRU II (410-32520-9) KC37, KC39  
LEM-I THRU II (410-32520-3) KCRL
2. MATED CONFIGURATION
3. \*\* MSC CABLE SET 410-11100-1
4. \*\*\* MSC CABLE SET 410-11170-3  
\*\*\* KSC GEN CABLE SET 410-11170-5
5. \*\* KSC @ LC-#37 410-11140-1; LC-#39 410-11130-1  
@ C & C BLDG 410-11210-1; VAB 410-11150-13 (BAY 1) 410-11150-15 (BAY 3)

**RADARS-GSE CHECKOUT - KSC AND MSC CONFIGURATION**

T30405-94  
APRIL 66

136

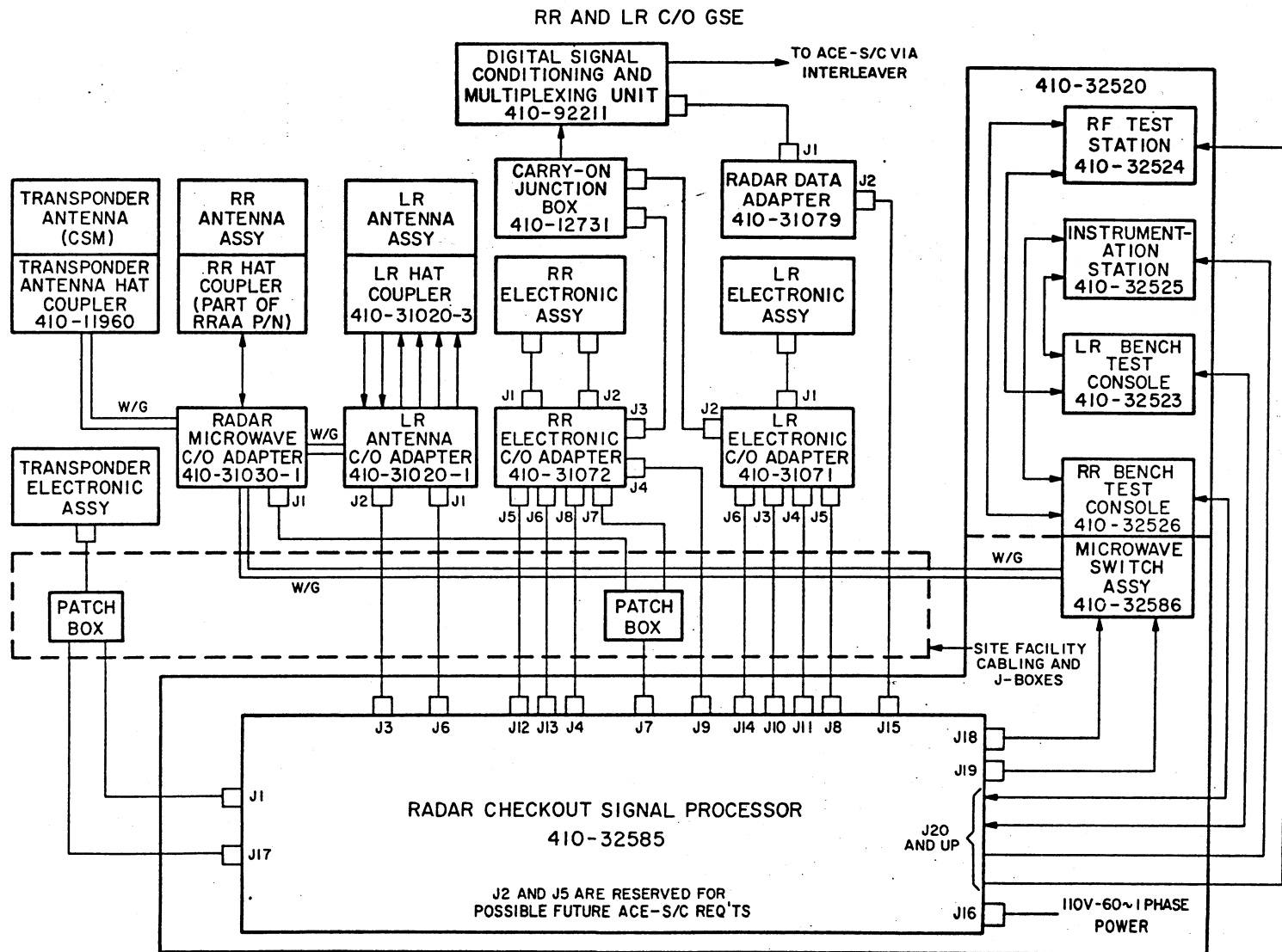

SECTION LEVEL RADAR CHECKOUT CONFIGURATION USING 410-32520 BTME

T30405-95  
APRIL 66

Fig. 5-3

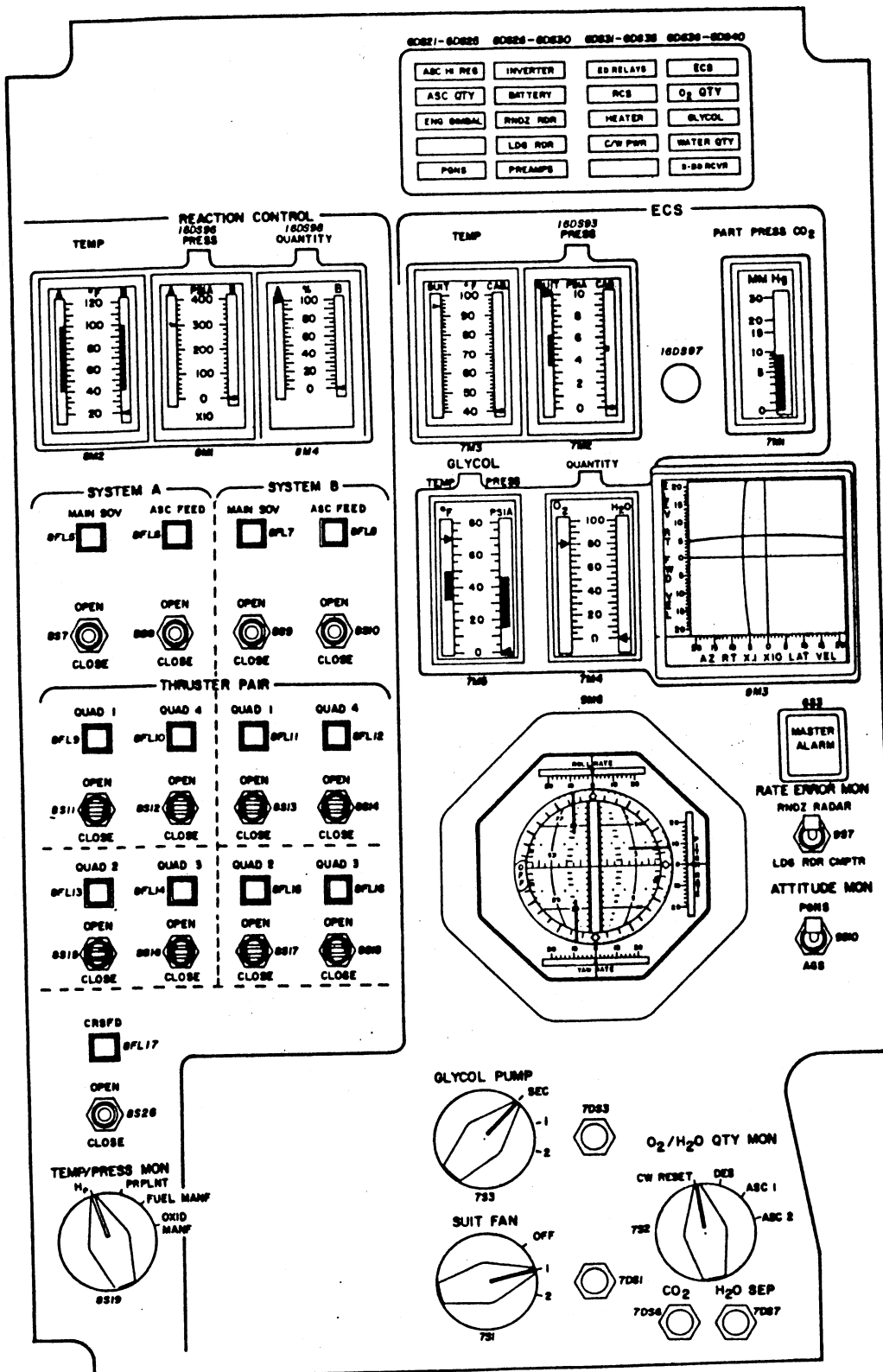
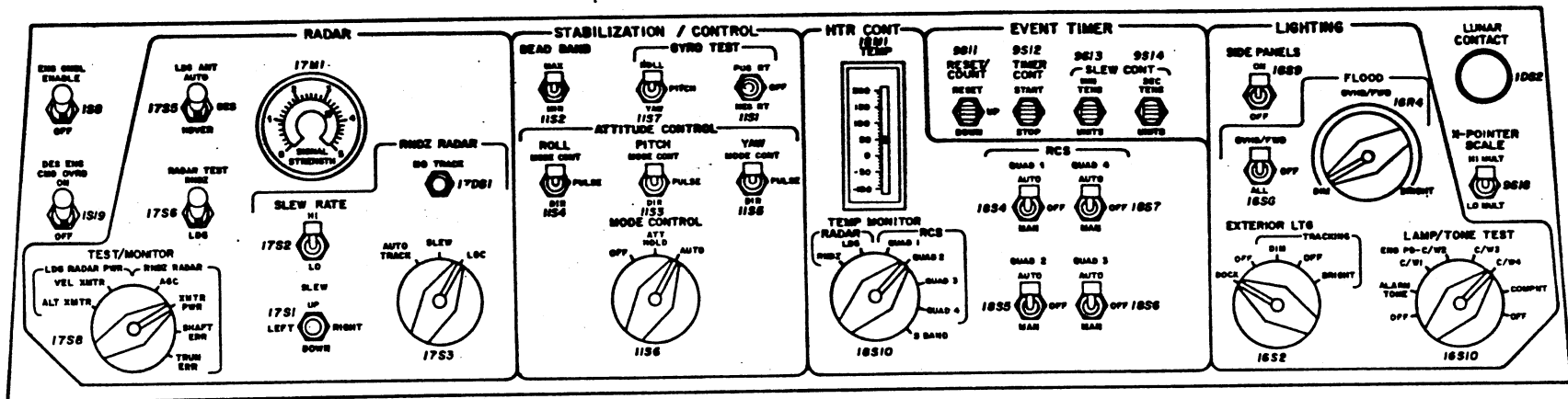

FIGURE 6-3. SYSTEM ENGINEER'S CENTER PANEL (PL II)



6-5

FIGURE 6-4. RADAR AND STABILIZATION/CONTROL PANEL (PL III)

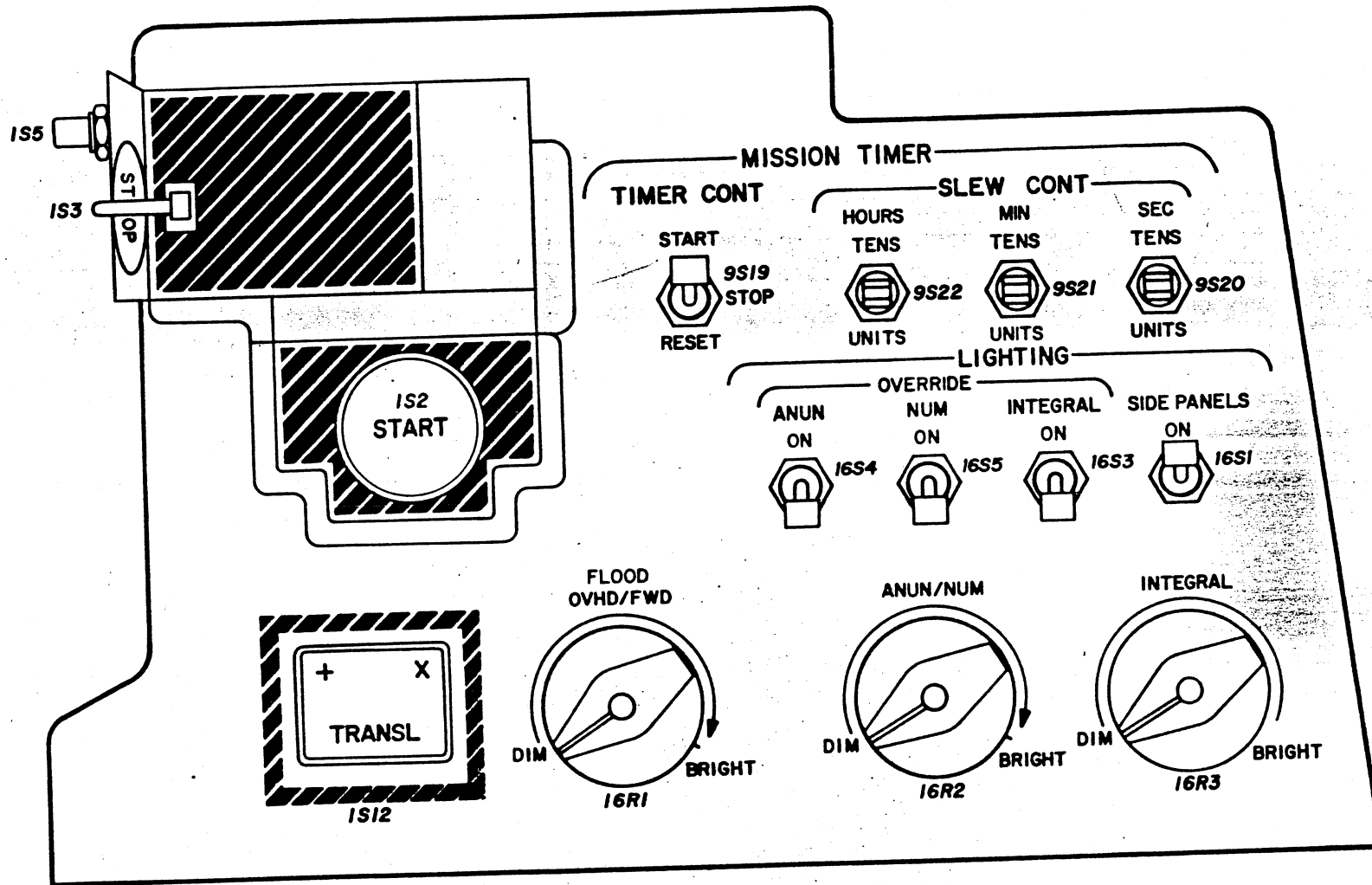

FIGURE 6-5. PANEL V

